

HS GROUP[®]

AUTOMOTIVE LED LIGHT LEADER

**VEDERCI MEGLIO ALLA GUIDA
VIAGGIANDO IN SICUREZZA**

30TH
ANNIVERSARY

UPGRADING 25.2



RoHS



www.happysoundgroup.com

HAPPY SOUND GROUP è un'azienda Sammarinese che opera nel settore della tecnologia dei veicoli da oltre 30 anni.

Oggi HAPPY SOUND GROUP è leader nella tecnologia a led per veicoli.

Ci rechiamo personalmente presso i nostri fornitori nel mondo per verificare che rispettino la qualità costruttiva da noi richiesta e progettata. Infatti i nostri fornitori costruiscono molti prodotti su nostro progetto esclusivo, questo ci permette di commercializzare articoli unici nel settore.

La qualità, l'innovazione, sono il nostro motto.

Commercializziamo prodotti con il nostro packaging brand "HS GROUP" tramite la nostra rete vendita. Da tempo siamo fornitori di grandi aziende italiane e consorzi di ricambisti.

Il nostro staff è composto da personale tecnico e commerciale con elevata esperienza, che mettiamo al Vostro servizio.

Tutti i nostri articoli sono omologati e sono da noi garantiti a termini di legge.

**ESPONIAMO AD AUTOPROMOTEC
- BOLOGNA DAL 21 AL 24 MAGGIO 2025 -**



HS GROUP SEMPRE ALL'AVANGUARDIA AL VOSTRO FIANCO



GIOVANNI TEREZI
C.E.O.
Direttore Tecnico e Amministrativo



FABIO GENTILE
Commercial & Marketing Director
Import/Export Director



FRANCESCA MARIA IVAGNES
Segreteria di Direzione



**MASSIMO MATASSOLI
MARIUS MUSTAFARAJ**
Magazzino e Spedizioni

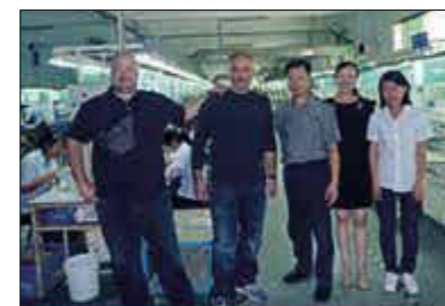

NOVITÀ ASSOLUTA: UTILIZZO SIA PARABOLA CHE LENTICOLARE!!!



LUNGA DURATA:
VENTOLINA DI
RAFFREDDAMENTO
AD ALTA
TECNOLOGIA

SMALL SIZE 1:1
DIMENSIONI COME L'ORIGINALE

CANBUS NO ERROR

8000
LUMEN
PER LAMPADA

LUCE FREDDA 6000K

PLUG AND PLAY

ILLUMINAZIONE 360°

ART. 40302

H7



PLUG AND PLAY PARABOLA E LENTICOLARE (2 PCS.)

- LED POWER: 28W (SINGLE)
- COMPONENTE LED CHIP DI ELEVATA EFFICIENZA E QUALITÀ
- PRODOTTO IN ALLUMINIO 6063
- DOPPIO DISSIPATORE DEL CALORE CON VENTOLA
- DC 12V-16V
- WATERPROOF: IP67
- 8000LM (LUMEN)
- TEMPERATURA COLORE: 6000K
- LIFETIME: >30.000 ORE
- TEMPERATURA OPERATIVA: DA -40°C A +80°C
- ANGOLO FASCIO D'ILLUMINAZIONE REGOLABILE A 360°

ART. 40301

H4



PLUG AND PLAY PARABOLA E LENTICOLARE (2 PCS.)

- LED POWER: 28W/28W (HIGH/LOW)
- COMPONENTE LED CHIP DI ELEVATA EFFICIENZA E QUALITÀ
- PRODOTTO IN ALLUMINIO 6063
- DOPPIO DISSIPATORE DEL CALORE CON VENTOLA
- DC 12V-16V
- WATERPROOF: IP67
- 8000LM (LUMEN)
- TEMPERATURA COLORE: 6000K
- LIFETIME: >30.000 ORE
- TEMPERATURA OPERATIVA: DA -40°C A +80°C
- ANGOLO FASCIO D'ILLUMINAZIONE REGOLABILE A 360°

ART. 40303

H11-H8-H9



PLUG AND PLAY PARABOLA E LENTICOLARE (2 PCS.)

- LED POWER: 28W (SINGLE)
- COMPONENTE LED CHIP DI ELEVATA EFFICIENZA E QUALITÀ
- PRODOTTO IN ALLUMINIO 6063
- DOPPIO DISSIPATORE DEL CALORE CON VENTOLA
- DC 12V-16V
- WATERPROOF: IP67
- 8000LM (LUMEN)
- TEMPERATURA COLORE: 6000K
- LIFETIME: >30.000 ORE
- TEMPERATURA OPERATIVA: DA -40°C A +80°C
- ANGOLO FASCIO D'ILLUMINAZIONE REGOLABILE A 360°

ART. 40304

HB3-9005



PLUG AND PLAY PARABOLA E LENTICOLARE (2 PCS.)

- LED POWER: 28W (SINGLE)
- COMPONENTE LED CHIP DI ELEVATA EFFICIENZA E QUALITÀ
- PRODOTTO IN ALLUMINIO 6063
- DOPPIO DISSIPATORE DEL CALORE CON VENTOLA
- DC 12V-16V
- WATERPROOF: IP67
- 8000LM (LUMEN)
- TEMPERATURA COLORE: 6000K
- LIFETIME: >30.000 ORE
- TEMPERATURA OPERATIVA: DA -40°C A +80°C
- ANGOLO FASCIO D'ILLUMINAZIONE REGOLABILE A 360°

ART. 40307

HB4-9006



PLUG AND PLAY PARABOLA E LENTICOLARE (2 PCS.)

- LED POWER: 28W (SINGLE)
- COMPONENTE LED CHIP DI ELEVATA EFFICIENZA E QUALITÀ
- PRODOTTO IN ALLUMINIO 6063
- DOPPIO DISSIPATORE DEL CALORE CON VENTOLA
- DC 12V-16V
- WATERPROOF: IP67
- 8000LM (LUMEN)
- TEMPERATURA COLORE: 6000K
- LIFETIME: >30.000 ORE
- TEMPERATURA OPERATIVA: DA -40°C A +80°C
- ANGOLO FASCIO D'ILLUMINAZIONE REGOLABILE A 360°

ART. 40305

HIR2-9012



PLUG AND PLAY PARABOLA E LENTICOLARE (2 PCS.)

- LED POWER: 28W (SINGLE)
- COMPONENTE LED CHIP DI ELEVATA EFFICIENZA E QUALITÀ
- PRODOTTO IN ALLUMINIO 6063
- DOPPIO DISSIPATORE DEL CALORE CON VENTOLA
- DC 12V-16V
- WATERPROOF: IP67
- 8000LM (LUMEN)
- TEMPERATURA COLORE: 6000K
- LIFETIME: >30.000 ORE
- TEMPERATURA OPERATIVA: DA -40°C A +80°C
- ANGOLO FASCIO D'ILLUMINAZIONE REGOLABILE A 360°

ART. 40306

H1



PLUG AND PLAY PARABOLA E LENTICOLARE (2 PCS.)

- LED POWER: 28W (SINGLE)
- COMPONENTE LED CHIP DI ELEVATA EFFICIENZA E QUALITÀ
- PRODOTTO IN ALLUMINIO 6063
- DOPPIO DISSIPATORE DEL CALORE CON VENTOLA
- DC 12V-16V
- WATERPROOF: IP67
- 8000LM (LUMEN)
- TEMPERATURA COLORE: 6000K
- LIFETIME: >30.000 ORE
- TEMPERATURA OPERATIVA: DA -40°C A +80°C
- ANGOLO FASCIO D'ILLUMINAZIONE REGOLABILE A 360°

EXTRA SMALL CON VENTOLA (LA GAMMA PIÙ COMPLETA)

IL KIT A LED DELLA SERIE SMALL LINE È DI DIMENSIONI ESTREMAMENTE CONTENUTE E PERTANTO LA SUA INSTALLAZIONE RISULTA POSSIBILE ANCHE DOVE LO SPAZIO È RIDOTTO. INSTALLAZIONE PLUG AND PLAY.



**SMALL SIZE 1:1
DIMENSIONI COME L'ORIGINALE**

CANBUS NO ERROR

LUCE FREDDA 6000K

**HEAT DISSIPATION FAST
RAFFREDDAMENTO VELOCE**

PLUG AND PLAY

**6500
LUMEN
PER LAMPADA**

**ADJUSTABLE
360° BEAM ANGLE
ANGOLO FASCIO DI
LUCE REGOLABILE 360°**

ART. 40852A

H7



1:1 STESSE DIMENSIONI DELLA LAMPADA ALOGENA ORIGINALE

LED HEADLIGHTS SET SMALL LINE (2 PCS.)

- LED POWER: 35W (SINGLE)
- HOUSING MATERIAL: AVIATION ALUMINIUM 6063
- DUAL FAN SYSTEM HEAT DISSIPATION
- DC 12V-16V
- WATERPROOF: IP67
- 6500LM (LUMEN)
- COLOR TEMPERATURE: 6000K
- LIFETIME: >30.000 HOURS
- OPERATING TEMPERATURE: DA -40°C A +80°C
- BEAM ANGLE: 360°
- WATERPROOF: IP67
- 6500LM (LUMEN)
- TEMPERATURA COLORE: 6000K
- LIFETIME: >30.000 ORE
- TEMPERATURA OPERATIVA: DA -40°C A +80°C
- ANGOLO FASCIO D'ILLUMINAZIONE REGOLABILE A 360°

ART. 40851A

H4



LED HEADLIGHTS SET SMALL LINE (2 PCS.)

- LED POWER: 35W/35W (HIGH/LOW)
- HOUSING MATERIAL: AVIATION ALUMINIUM 6063
- DUAL FAN SYSTEM HEAT DISSIPATION
- DC 12V-16V
- WATERPROOF: IP67
- 6500LM (LUMEN)
- COLOR TEMPERATURE: 6000K
- LIFETIME: >30.000 HOURS
- OPERATING TEMPERATURE: DA -40°C A +80°C
- BEAM ANGLE: 360°
- WATERPROOF: IP67
- 6500LM (LUMEN)
- TEMPERATURA COLORE: 6000K
- LIFETIME: >30.000 ORE
- TEMPERATURA OPERATIVA: DA -40°C A +80°C
- ANGOLO FASCIO D'ILLUMINAZIONE REGOLABILE A 360°

ART. 40853A

H11-H8-H9-H16

1:1 STESSE DIMENSIONI DELLA LAMPADA ALOGENA ORIGINALE



LED HEADLIGHTS SET SMALL LINE (2 PCS.)

- LED POWER: 35W (SINGLE)
- HOUSING MATERIAL: AVIATION ALUMINIUM 6063
- DUAL FAN SYSTEM HEAT DISSIPATION
- DC 12V-16V
- WATERPROOF: IP67
- 6500LM (LUMEN)
- COLOR TEMPERATURE: 6000K
- LIFETIME: >30.000 HOURS
- OPERATING TEMPERATURE: DA -40°C A +80°C
- BEAM ANGLE: 360°
- WATERPROOF: IP67
- 6500LM (LUMEN)
- TEMPERATURA COLORE: 6000K
- LIFETIME: >30.000 ORE
- TEMPERATURA OPERATIVA: DA -40°C A +80°C
- ANGOLO FASCIO D'ILLUMINAZIONE REGOLABILE A 360°

ART. 40854A

HB3-9005-H10



LED HEADLIGHTS SET SMALL LINE (2 PCS.)

- LED POWER: 35W (SINGLE)
- HOUSING MATERIAL: AVIATION ALUMINIUM 6063
- DUAL FAN SYSTEM HEAT DISSIPATION
- DC 12V-16V
- WATERPROOF: IP67
- 6500LM (LUMEN)
- COLOR TEMPERATURE: 6000K
- LIFETIME: >30.000 HOURS
- OPERATING TEMPERATURE: DA -40°C A +80°C
- BEAM ANGLE: 360°
- WATERPROOF: IP67
- 6500LM (LUMEN)
- TEMPERATURA COLORE: 6000K
- LIFETIME: >30.000 ORE
- TEMPERATURA OPERATIVA: DA -40°C A +80°C
- ANGOLO FASCIO D'ILLUMINAZIONE REGOLABILE A 360°

ART. 40857A

HB4-9006



LED HEADLIGHTS SET SMALL LINE (2 PCS.)

- LED POWER: 35W (SINGLE)
- HOUSING MATERIAL: AVIATION ALUMINIUM 6063
- DUAL FAN SYSTEM HEAT DISSIPATION
- DC 12V-16V
- WATERPROOF: IP67
- 6500LM (LUMEN)
- COLOR TEMPERATURE: 6000K
- LIFETIME: >30.000 HOURS
- OPERATING TEMPERATURE: DA -40°C A +80°C
- BEAM ANGLE: 360°
- WATERPROOF: IP67
- 6500LM (LUMEN)
- TEMPERATURA COLORE: 6000K
- LIFETIME: >30.000 ORE
- TEMPERATURA OPERATIVA: DA -40°C A +80°C
- ANGOLO FASCIO D'ILLUMINAZIONE REGOLABILE A 360°

ART. 40855A

HIR2-9012



LED HEADLIGHTS SET SMALL LINE (2 PCS.)

- LED POWER: 35W (SINGLE)
- HOUSING MATERIAL: AVIATION ALUMINIUM 6063
- DUAL FAN SYSTEM HEAT DISSIPATION
- DC 12V-16V
- WATERPROOF: IP67
- 6500LM (LUMEN)
- COLOR TEMPERATURE: 6000K
- LIFETIME: >30.000 HOURS
- OPERATING TEMPERATURE: DA -40°C A +80°C
- BEAM ANGLE: 360°
- WATERPROOF: IP67
- 6500LM (LUMEN)
- TEMPERATURA COLORE: 6000K
- LIFETIME: >30.000 ORE
- TEMPERATURA OPERATIVA: DA -40°C A +80°C
- ANGOLO FASCIO D'ILLUMINAZIONE REGOLABILE A 360°

ART. 40856A

H1



LED HEADLIGHTS SET SMALL LINE (2 PCS.)

- LED POWER: 35W (SINGLE)
- HOUSING MATERIAL: AVIATION ALUMINIUM 6063
- DUAL FAN SYSTEM HEAT DISSIPATION
- DC 12V-16V
- WATERPROOF: IP67
- 6500LM (LUMEN)
- COLOR TEMPERATURE: 6000K
- LIFETIME: >30.000 HOURS
- OPERATING TEMPERATURE: DA -40°C A +80°C
- BEAM ANGLE: 360°

- LED POWER: 35W (SINGLE)
- COMPONENTE LED CHIP DI ELEVATA EFFICIENZA E QUALITÀ, STUDIATO SPECIFICAMENTE PER KIT A LED
- PRODOTTO IN ALLUMINIO 6063
- DOPPIO DISSIPATORE DEL CALORE CON VENTOLA
- DC 12V-16V
- WATERPROOF: IP67
- 6500LM (LUMEN)
- TEMPERATURA COLORE: 6000K
- LIFETIME: >30.000 ORE
- TEMPERATURA OPERATIVA: DA -40°C A +80°C
- ANGOLO FASCIO D'ILLUMINAZIONE REGOLABILE A 360°

ART. 40859A

H3



LED HEADLIGHTS SET SMALL LINE (2 PCS.)

- LED POWER: 35W (SINGLE)
- HOUSING MATERIAL: AVIATION ALUMINIUM 6063
- DUAL FAN SYSTEM HEAT DISSIPATION
- DC 12V-16V
- WATERPROOF: IP67
- 6500LM (LUMEN)
- COLOR TEMPERATURE: 6000K
- LIFETIME: >30.000 HOURS
- OPERATING TEMPERATURE: DA -40°C A +80°C
- BEAM ANGLE: 360°

- LED POWER: 35W (SINGLE)
- COMPONENTE LED CHIP DI ELEVATA EFFICIENZA E QUALITÀ, STUDIATO SPECIFICAMENTE PER KIT A LED
- PRODOTTO IN ALLUMINIO 6063
- DOPPIO DISSIPATORE DEL CALORE CON VENTOLA
- DC 12V-16V
- WATERPROOF: IP67
- 6500LM (LUMEN)
- TEMPERATURA COLORE: 6000K
- LIFETIME: >30.000 ORE
- TEMPERATURA OPERATIVA: DA -40°C A +80°C
- ANGOLO FASCIO D'ILLUMINAZIONE REGOLABILE A 360°

ART. 40871A

P13W-PSX26W



LED HEADLIGHTS SET SMALL LINE (2 PCS.)

- LED POWER: 35W (SINGLE)
- HOUSING MATERIAL: AVIATION ALUMINIUM 6063
- DUAL FAN SYSTEM HEAT DISSIPATION
- DC 12V-16V
- WATERPROOF: IP67
- 6500LM (LUMEN)
- COLOR TEMPERATURE: 6000K
- LIFETIME: >30.000 HOURS
- OPERATING TEMPERATURE: DA -40°C A +80°C
- BEAM ANGLE: 360°

- LED POWER: 35W (SINGLE)
- COMPONENTE LED CHIP DI ELEVATA EFFICIENZA E QUALITÀ, STUDIATO SPECIFICAMENTE PER KIT A LED
- PRODOTTO IN ALLUMINIO 6063
- DOPPIO DISSIPATORE DEL CALORE CON VENTOLA
- DC 12V-16V
- WATERPROOF: IP67
- 6500LM (LUMEN)
- TEMPERATURA COLORE: 6000K
- LIFETIME: >30.000 ORE
- TEMPERATURA OPERATIVA: DA -40°C A +80°C
- ANGOLO FASCIO D'ILLUMINAZIONE REGOLABILE A 360°

ART. 40869A

PSX24W-5202



LED HEADLIGHTS SET SMALL LINE (2 PCS.)

- LED POWER: 35W (SINGLE)
- HOUSING MATERIAL: AVIATION ALUMINIUM 6063
- DUAL FAN SYSTEM HEAT DISSIPATION
- DC 12V-16V
- WATERPROOF: IP67
- 6500LM (LUMEN)
- COLOR TEMPERATURE: 6000K
- LIFETIME: >30.000 HOURS
- OPERATING TEMPERATURE: DA -40°C A +80°C
- BEAM ANGLE: 360°

- LED POWER: 35W (SINGLE)
- COMPONENTE LED CHIP DI ELEVATA EFFICIENZA E QUALITÀ, STUDIATO SPECIFICAMENTE PER KIT A LED
- PRODOTTO IN ALLUMINIO 6063
- DOPPIO DISSIPATORE DEL CALORE CON VENTOLA
- DC 12V-16V
- WATERPROOF: IP67
- 6500LM (LUMEN)
- TEMPERATURA COLORE: 6000K
- LIFETIME: >30.000 ORE
- TEMPERATURA OPERATIVA: DA -40°C A +80°C
- ANGOLO FASCIO D'ILLUMINAZIONE REGOLABILE A 360°

ART. 40861A

H27-880-881



LED HEADLIGHTS SET SMALL LINE (2 PCS.)

- LED POWER: 35W (SINGLE)
- HOUSING MATERIAL: AVIATION ALUMINIUM 6063
- DUAL FAN SYSTEM HEAT DISSIPATION
- DC 12V-16V
- WATERPROOF: IP67
- 6500LM (LUMEN)
- COLOR TEMPERATURE: 6000K
- LIFETIME: >30.000 HOURS
- OPERATING TEMPERATURE: DA -40°C A +80°C
- BEAM ANGLE: 360°

- LED POWER: 35W (SINGLE)
- COMPONENTE LED CHIP DI ELEVATA EFFICIENZA E QUALITÀ, STUDIATO SPECIFICAMENTE PER KIT A LED
- PRODOTTO IN ALLUMINIO 6063
- DOPPIO DISSIPATORE DEL CALORE CON VENTOLA
- DC 12V-16V
- WATERPROOF: IP67
- 6500LM (LUMEN)
- TEMPERATURA COLORE: 6000K
- LIFETIME: >30.000 ORE
- TEMPERATURA OPERATIVA: DA -40°C A +80°C
- ANGOLO FASCIO D'ILLUMINAZIONE REGOLABILE A 360°

ART. 40863A

H13-9008



LED HEADLIGHTS SET SMALL LINE (2 PCS.)

- LED POWER: 35W/35W (HIGH/LOW)
- HOUSING MATERIAL: AVIATION ALUMINIUM 6063
- DUAL FAN SYSTEM HEAT DISSIPATION
- DC 12V-16V
- WATERPROOF: IP67
- 6500LM (LUMEN)
- COLOR TEMPERATURE: 6000K
- LIFETIME: >30.000 HOURS
- OPERATING TEMPERATURE: DA -40°C A +80°C
- BEAM ANGLE: 360°

- LED POWER: 35W/35W (HIGH/LOW)
- COMPONENTE LED CHIP DI ELEVATA EFFICIENZA E QUALITÀ, STUDIATO SPECIFICAMENTE PER KIT A LED
- PRODOTTO IN ALLUMINIO 6063
- DOPPIO DISSIPATORE DEL CALORE CON VENTOLA
- DC 12V-16V
- WATERPROOF: IP67
- 6500LM (LUMEN)
- TEMPERATURA COLORE: 6000K
- LIFETIME: >30.000 ORE
- TEMPERATURA OPERATIVA: DA -40°C A +80°C
- ANGOLO FASCIO D'ILLUMINAZIONE REGOLABILE A 360°

ART. 40865A

HB1-9004



LED HEADLIGHTS SET SMALL LINE (2 PCS.)

- LED POWER: 35W/35W (HIGH/LOW)
- HOUSING MATERIAL: AVIATION ALUMINIUM 6063
- DUAL FAN SYSTEM HEAT DISSIPATION
- DC 12V-16V
- WATERPROOF: IP67
- 6500LM (LUMEN)
- COLOR TEMPERATURE: 6000K
- LIFETIME: >30.000 HOURS
- OPERATING TEMPERATURE: DA -40°C A +80°C
- BEAM ANGLE: 360°

- LED POWER: 35W/35W (HIGH/LOW)
- COMPONENTE LED CHIP DI ELEVATA EFFICIENZA E QUALITÀ, STUDIATO SPECIFICAMENTE PER KIT A LED
- PRODOTTO IN ALLUMINIO 6063
- DOPPIO DISSIPATORE DEL CALORE CON VENTOLA
- DC 12V-16V
- WATERPROOF: IP67
- 6500LM (LUMEN)
- TEMPERATURA COLORE: 6000K
- LIFETIME: >30.000 ORE
- TEMPERATURA OPERATIVA: DA -40°C A +80°C
- ANGOLO FASCIO D'ILLUMINAZIONE REGOLABILE A 360°

PLUG AND PLAY QUICK START

KIT A LED DI SEMPLICE INSTALLAZIONE GRAZIE ALLA TECNOLOGIA PLUG AND PLAY.
PUÒ ESSERE UTILIZZATO PER GLI ANABBAGLIANTI, FENDINEBBIA
ED ABBAGLIANTI GRAZIE ALLA SUA PRATICITÀ DI UTILIZZO.



LUNGA DURATA

BEST LED TECHNOLOGY

**SMALL SIZE
DIMENSIONI COME
L'ORIGINALE**

**ALUMINUM
LIGHT BODY
PLUG AND PLAY**

**5000 LUMEN
PER LAMPADA**

ART. 40552B



H7
H18

KIT FARI A LED PLUG AND PLAY (COMPOSTO DA 2 PEZZI)

- LED POWER: 30W (SINGLE)
- COMPONENTE LED CHIP DI ELEVATA EFFICIENZA E QUALITÀ, STUDIATO SPECIFICAMENTE PER KIT A LED
- PRODOTTO IN ALLUMINIO
- DOTATO DI DISSIPATORE DEL CALORE
- DC 11V-18V
- INPUT 1.2A±0.1A
- WATERPROOF: IP65
- 5000LM (LUMEN)
- TEMPERATURA COLORE: 6000K
- LIFETIME: >30.000 ORE
- TEMPERATURA OPERATIVA: DA -40°C A +80°C

**1:1 STESS
DIMENSIONI
DELLA LAMPADA
ALOGENA
ORIGINALE**



ART. 40551B



H4
H19

KIT FARI A LED PLUG AND PLAY (COMPOSTO DA 2 PEZZI)

- LED POWER: 30W (HIGH/LOW)
- COMPONENTE LED CHIP DI ELEVATA EFFICIENZA E QUALITÀ, STUDIATO SPECIFICAMENTE PER KIT A LED
- PRODOTTO IN ALLUMINIO
- DOTATO DI DISSIPATORE DEL CALORE
- DC 11V-18V
- INPUT 1.2A±0.1A
- WATERPROOF: IP65
- 5000LM (LUMEN)
- TEMPERATURA COLORE: 6000K
- LIFETIME: >30.000 ORE
- TEMPERATURA OPERATIVA: DA -50°C A +90°C

ART. 40553B



H11-H8-H9

KIT FARI A LED PLUG AND PLAY (COMPOSTO DA 2 PEZZI)

- LED POWER: 30W (SINGLE)
- COMPONENTE LED CHIP DI ELEVATA EFFICIENZA E QUALITÀ, STUDIATO SPECIFICAMENTE PER KIT A LED
- PRODOTTO IN ALLUMINIO
- DOTATO DI DISSIPATORE DEL CALORE
- DC 11V-18V
- INPUT 1.2A±0.1A
- WATERPROOF: IP65
- 5000LM (LUMEN)
- TEMPERATURA COLORE: 6000K
- LIFETIME: >30.000 ORE
- TEMPERATURA OPERATIVA: DA -40°C A +80°C

ART. 40556B



H1

KIT FARI A LED PLUG AND PLAY (COMPOSTO DA 2 PEZZI)

- LED POWER: 30W (SINGLE)
- COMPONENTE LED CHIP DI ELEVATA EFFICIENZA E QUALITÀ, STUDIATO SPECIFICAMENTE PER KIT A LED
- PRODOTTO IN ALLUMINIO
- DOTATO DI DISSIPATORE DEL CALORE
- DC 11V-18V
- INPUT 1.2A±0.1A
- WATERPROOF: IP65
- 5000LM (LUMEN)
- TEMPERATURA COLORE: 6000K
- LIFETIME: >30.000 ORE
- TEMPERATURA OPERATIVA: DA -40°C A +80°C

ART. 40554B



HB3-9005

KIT FARI A LED PLUG AND PLAY (COMPOSTO DA 2 PEZZI)

- LED POWER: 30W (SINGLE)
- COMPONENTE LED CHIP DI ELEVATA EFFICIENZA E QUALITÀ, STUDIATO SPECIFICAMENTE PER KIT A LED
- PRODOTTO IN ALLUMINIO
- DOTATO DI DISSIPATORE DEL CALORE
- DC 11V-18V
- INPUT 1.2A±0.1A
- WATERPROOF: IP65
- 5000LM (LUMEN)
- TEMPERATURA COLORE: 6000K
- LIFETIME: >30.000 ORE
- TEMPERATURA OPERATIVA: DA -40°C A +80°C

ART. 40559B



H3

KIT FARI A LED PLUG AND PLAY (COMPOSTO DA 2 PEZZI)

- LED POWER: 30W (SINGLE)
- COMPONENTE LED CHIP DI ELEVATA EFFICIENZA E QUALITÀ, STUDIATO SPECIFICAMENTE PER KIT A LED
- PRODOTTO IN ALLUMINIO
- DOTATO DI DISSIPATORE DEL CALORE
- DC 11V-18V
- INPUT 1.2A±0.1A
- WATERPROOF: IP65
- 5000LM (LUMEN)
- TEMPERATURA COLORE: 6000K
- LIFETIME: >30.000 ORE
- TEMPERATURA OPERATIVA: DA -40°C A +80°C



PLUG AND PLAY

PLUG AND PLAY

PLUG AND PLAY PROFESSIONAL LINE



IL KIT A LED DELLA SERIE PRO È DI SEMPLICISSIMA INSTALLAZIONE GRAZIE ALLA TECNOLOGIA PLUG AND PLAY. IL KIT A LED PRO PUÒ ESSERE UTILIZZATO PER GLI ANABBAGLIANTI E SOPRATTUTTO PER FENDINEBBIA ED ABBAGLIANTI GRAZIE ALLA SUA PRATICITÀ DI UTILIZZO.



12/24 VOLT

1:1 STESSE DIMENSIONI DELLA LAMPADA ALOGENA ORIGINALE

6800 LUMEN
PER LAMPADA

FANLESS COOLER SINK
DISSIPATORE DI RAFFREDDAMENTO SENZA VENTOLA

ALUMINUM LIGHT BODY
PLUG AND PLAY



ART. 40602A

1:1 STESSE DIMENSIONI DELLA LAMPADA ALOGENA ORIGINALE



H7-H18

LED HEADLIGHTS SET PLUG AND PLAY (2 PCS.)

- LED POWER: 35W (SINGLE)
- HOUSING MATERIAL: AVIATION ALUMINUM, RED COPPER
- HEAT DISSIPATION
- DC 12/24 VOLT
- INPUT 2.5A
- WATERPROOF: IP68
- 6800LM (LUMEN)
- COLOR TEMPERATURE: 6000K
- LIFETIME: >30.000 HOURS
- OPERATING TEMPERATURE: DA -40°C A +80°C
- BEAM ANGLE: 360°

KIT FARI A LED PLUG AND PLAY (COMPOSTO DA 2 PEZZI)

- LED POWER: 35W (SINGLE)
- COMPONENTE LED CHIP DI ELEVATA EFFICIENZA E QUALITÀ, STUDIATO SPECIFICAMENTE PER KIT A LED
- PRODOTTO IN ALLUMINIO
- DOTATO DI DISSIPATORE DEL CALORE
- DC 12/24 VOLT
- INPUT 2.5A
- WATERPROOF: IP68
- 6800LM (LUMEN)
- TEMPERATURA COLORE: 6000K
- LIFETIME: >30.000 ORE
- TEMPERATURA OPERATIVA: DA -40°C A +80°C
- ANGOLO FASCIO D'ILLUMINAZIONE REGOLABILE A 360°

ART. 40601A



H4-H19

LED HEADLIGHTS SET PLUG AND PLAY (2 PCS.)

- LED POWER: 35W/30W (HIGH/LOW)
- HOUSING MATERIAL: AVIATION ALUMINUM, RED COPPER
- HEAT DISSIPATION
- DC 12/24 VOLT
- INPUT 2.5A
- WATERPROOF: IP68
- 6800LM (LUMEN)
- COLOR TEMPERATURE: 6000K
- LIFETIME: >30.000 HOURS
- OPERATING TEMPERATURE: DA -40°C A +80°C
- BEAM ANGLE: 360°

KIT FARI A LED PLUG AND PLAY (COMPOSTO DA 2 PEZZI)

- LED POWER: 35W/30W (HIGH/LOW)
- COMPONENTE LED CHIP DI ELEVATA EFFICIENZA E QUALITÀ, STUDIATO SPECIFICAMENTE PER KIT A LED
- PRODOTTO IN ALLUMINIO
- DOTATO DI DISSIPATORE DEL CALORE
- DC 12/24 VOLT
- INPUT 2.5A
- WATERPROOF: IP68
- 6800LM (LUMEN)
- TEMPERATURA COLORE: 6000K
- LIFETIME: >30.000 ORE
- TEMPERATURA OPERATIVA: DA -40°C A +80°C
- ANGOLO FASCIO D'ILLUMINAZIONE REGOLABILE A 360°



PLUG AND PLAY

PLUG AND PLAY

ART. 40603A



H11-H8

H9-H16

LED HEADLIGHTS SET PLUG AND PLAY (2 PCS.)

- LED POWER: 35W (SINGLE)
- HOUSING MATERIAL: AVIATION ALUMINUM, RED COPPER
- HEAT DISSIPATION
- DC 12/24 VOLT
- INPUT 2.5A
- WATERPROOF: IP68
- 6800LM (LUMEN)
- COLOR TEMPERATURE: 6000K
- LIFETIME: >30.000 HOURS
- OPERATING TEMPERATURE: DA -40°C A +80°C
- BEAM ANGLE: 360°

KIT FARI A LED PLUG AND PLAY (COMPOSTO DA 2 PEZZI)

- LED POWER: 35W (SINGLE)
- COMPONENTE LED CHIP DI ELEVATA EFFICIENZA E QUALITÀ, STUDIATO SPECIFICAMENTE PER KIT A LED
- PRODOTTO IN ALLUMINIO
- DOTATO DI DISSIPATORE DEL CALORE
- DC 12/24 VOLT
- INPUT 2.5A
- WATERPROOF: IP68
- 6800LM (LUMEN)
- TEMPERATURA COLORE: 6000K
- LIFETIME: >30.000 ORE
- TEMPERATURA OPERATIVA: DA -40°C A +80°C
- ANGOLO FASCIO D'ILLUMINAZIONE REGOLABILE A 360°

ART. 40604 - HB3-9005

ART. 40607 - HB4-9006

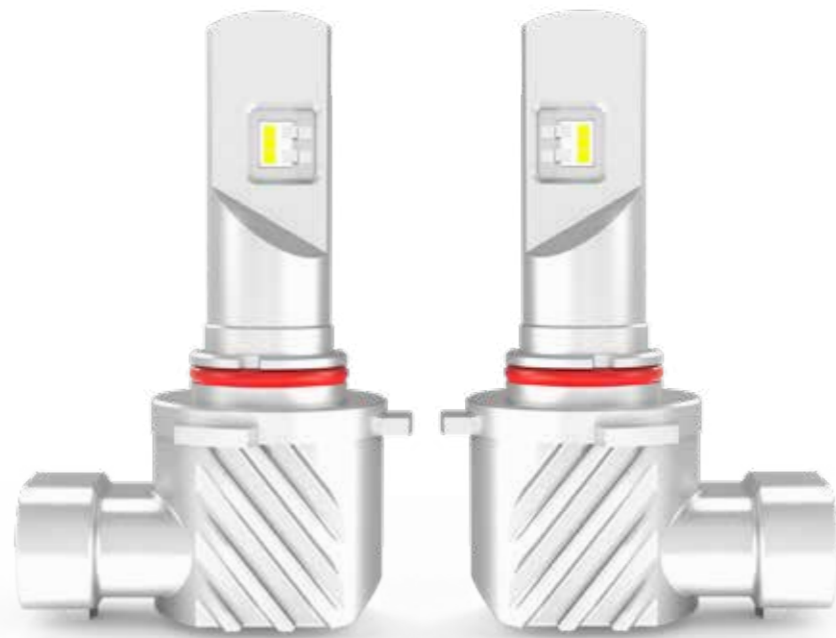

LED HEADLIGHTS SET PLUG AND PLAY (2 PCS.)

- LED POWER: 35W (SINGLE)
- HOUSING MATERIAL: AVIATION ALUMINUM, RED COPPER
- HEAT DISSIPATION
- DC 12/24 VOLT
- INPUT 2.5A
- WATERPROOF: IP68
- 6800LM (LUMEN)
- COLOR TEMPERATURE: 6000K
- LIFETIME: >30.000 HOURS
- OPERATING TEMPERATURE: DA -40°C A +80°C
- BEAM ANGLE: 360°

KIT FARI A LED PLUG AND PLAY (COMPOSTO DA 2 PEZZI)

- LED POWER: 35W (SINGLE)
- COMPONENTE LED CHIP DI ELEVATA EFFICIENZA E QUALITÀ, STUDIATO SPECIFICAMENTE PER KIT A LED
- PRODOTTO IN ALLUMINIO
- DOTATO DI DISSIPATORE DEL CALORE
- DC 12/24 VOLT
- INPUT 2.5A
- WATERPROOF: IP68
- 6800LM (LUMEN)
- TEMPERATURA COLORE: 6000K
- LIFETIME: >30.000 ORE
- TEMPERATURA OPERATIVA: DA -40°C A +80°C
- ANGOLO FASCIO D'ILLUMINAZIONE REGOLABILE A 360°

ART. 40586



H1

KIT FARI A LED PLUG AND PLAY (COMPOSTO DA 2 PEZZI)

- H1
- LED POWER: 30W (SINGLE)
- COMPONENTE LED CHIP DI ELEVATA EFFICIENZA E QUALITÀ, STUDIATO SPECIFICAMENTE PER KIT A LED
- PRODOTTO IN ALLUMINIO
- DOTATO DI DISSIPATORE DEL CALORE
- DC 12/24 VOLT
- INPUT 1.2A±0.1A
- WATERPROOF: IP67
- 6000LM (LUMEN)
- TEMPERATURA COLORE: 6000K
- LIFETIME: >10.000 ORE
- TEMPERATURA OPERATIVA: DA -50°C A +90°C

STESSE DIMENSIONI DELLA LAMPADA ORIGINALE

ART. 40589



H3

KIT FARI A LED PLUG AND PLAY (COMPOSTO DA 2 PEZZI)

- H3
- LED POWER: 30W (SINGLE)
- COMPONENTE LED CHIP DI ELEVATA EFFICIENZA E QUALITÀ, STUDIATO SPECIFICAMENTE PER KIT A LED
- PRODOTTO IN ALLUMINIO
- DOTATO DI DISSIPATORE DEL CALORE
- DC 12/24 VOLT
- INPUT 1.2A±0.1A
- WATERPROOF: IP67
- 6000LM (LUMEN)
- TEMPERATURA COLORE: 6000K
- LIFETIME: >10.000 ORE
- TEMPERATURA OPERATIVA: DA -50°C A +90°C

STESSE DIMENSIONI DELLA LAMPADA ORIGINALE

SUPER CANBUS
55 WATT STABILI

10.600 LUMEN
PER LAMPADA



INNOVATIVA VENTOLA DI RAFFREDDAMENTO

55 WATT CAN BUS ULTIMA GENERAZIONE

ALUMINUM LIGHT BODY



ART. 40702B



LED HEADLIGHTS SET (2 PCS.)

- LED POWER: 55W (SINGLE)
- HOUSING MATERIAL: AVIATION ALUMINUM, RED COPPER
- EQUIPPED WITH LATEST GENERATION FAN FOR TOTAL HEAT DISSIPATION
- 9-32VOLT DC
- WATERPROOF: IP68
- 10.600LM (LUMEN)
- COLOR TEMPERATURE: 6500K
- LIFETIME: >30.000 HOURS
- OPERATING TEMPERATURE: DA -50°C A +90°C
- LED POWER: 55W (SINGLE)
- COMPONENTE LED CHIP DI ELEVATA EFFICIENZA E QUALITÀ, STUDIATO SPECIFICAMENTE PER KIT A LED
- PRODOTTO IN ALLUMINIO
- DOTATO DI VENTOLA ULTIMA GENERAZIONE PER LA DISSIPAZIONE TOTALE DEL CALORE
- 9-32VOLT DC
- WATERPROOF: IP68
- 10.600LM (LUMEN)
- TEMPERATURA COLORE: 6500K
- LIFETIME: >30.000 ORE
- TEMPERATURA OPERATIVA: DA -50°C A +90°C

ART. 40701B



LED HEADLIGHTS SET (2 PCS.)

- 55W/36W (HIGH/LOW)
- HOUSING MATERIAL: AVIATION ALUMINUM, RED COPPER
- EQUIPPED WITH LATEST GENERATION FAN FOR TOTAL HEAT DISSIPATION
- 9-32VOLT DC
- WATERPROOF: IP68
- 10.600LM (LUMEN)
- COLOR TEMPERATURE: 6500K
- LIFETIME: >30.000 HOURS
- OPERATING TEMPERATURE: DA -50°C A +90°C
- 55W/36W (HIGH/LOW)
- COMPONENTE LED CHIP DI ELEVATA EFFICIENZA E QUALITÀ, STUDIATO SPECIFICAMENTE PER KIT A LED
- PRODOTTO IN ALLUMINIO
- DOTATO DI VENTOLA ULTIMA GENERAZIONE PER LA DISSIPAZIONE TOTALE DEL CALORE
- 9-32VOLT DC
- WATERPROOF: IP68
- 10.600LM (LUMEN)
- TEMPERATURA COLORE: 6500K
- LIFETIME: >30.000 ORE
- TEMPERATURA OPERATIVA: DA -50°C A +90°C

ART. 40703B



LED HEADLIGHTS SET (2 PCS.)

- LED POWER: 55W (SINGLE)
- HOUSING MATERIAL: AVIATION ALUMINUM, RED COPPER
- EQUIPPED WITH LATEST GENERATION FAN FOR TOTAL HEAT DISSIPATION
- 9-32VOLT DC
- WATERPROOF: IP68
- 10.600LM (LUMEN)
- COLOR TEMPERATURE: 6500K
- LIFETIME: >30.000 HOURS
- OPERATING TEMPERATURE: DA -50°C A +90°C
- LED POWER: 55W (SINGLE)
- COMPONENTE LED CHIP DI ELEVATA EFFICIENZA E QUALITÀ, STUDIATO SPECIFICAMENTE PER KIT A LED
- PRODOTTO IN ALLUMINIO
- DOTATO DI VENTOLA ULTIMA GENERAZIONE PER LA DISSIPAZIONE TOTALE DEL CALORE
- 9-32VOLT DC
- WATERPROOF: IP68
- 10.600LM (LUMEN)
- TEMPERATURA COLORE: 6500K
- LIFETIME: >30.000 ORE
- TEMPERATURA OPERATIVA: DA -50°C A +90°C

ART. 40704B



LED HEADLIGHTS SET (2 PCS.)

- LED POWER: 55W (SINGLE)
- HOUSING MATERIAL: AVIATION ALUMINUM, RED COPPER
- EQUIPPED WITH LATEST GENERATION FAN FOR TOTAL HEAT DISSIPATION
- 9-32VOLT DC
- WATERPROOF: IP68
- 10.600LM (LUMEN)
- COLOR TEMPERATURE: 6500K
- LIFETIME: >30.000 HOURS
- OPERATING TEMPERATURE: DA -50°C A +90°C
- LED POWER: 55W (SINGLE)
- COMPONENTE LED CHIP DI ELEVATA EFFICIENZA E QUALITÀ, STUDIATO SPECIFICAMENTE PER KIT A LED
- PRODOTTO IN ALLUMINIO
- DOTATO DI VENTOLA ULTIMA GENERAZIONE PER LA DISSIPAZIONE TOTALE DEL CALORE
- 9-32VOLT DC
- WATERPROOF: IP68
- 10.600LM (LUMEN)
- TEMPERATURA COLORE: 6500K
- LIFETIME: >30.000 ORE
- TEMPERATURA OPERATIVA: DA -50°C A +90°C



12.000 LUMEN PER LAMPADA

EXTRASMALL, SOLTANTO 7 CENTIMETRI.
VENTOLINA DI RAFFREDDAMENTO SUPER SILENZIOSA.
55 WATT DI ASSORBIMENTO. SUPER CANBUS.



CANBUS

12000LM PER LAMPADA

KIT A LED: ANABBAGLIANTI ABBAGLIANTI FENDINEBBIA

CE RoHS

ART. 40402 H7
ART. 40422 H18



LED HEADLIGHTS SET (2 PCS.)

- LED POWER: 55W (SINGLE)
- HOUSING MATERIAL: AVIATION ALUMINIUM, RED COPPER
- LAST GENERATION COOLING FAN
- 9-32VOLT DC
- WATERPROOF: IP68
- 12000LM (LUMEN)
- COLOR TEMPERATURE: 6700K
- LIFETIME: >30.000 HOURS
- OPERATING TEMPERATURE: DA -50°C A +90°C
- LIGHT SOURCE MODEL: G-XP X3 CUSTOMIZED

KIT FARI A LED (COMPOSTO DA 2 PEZZI)

- LED POWER: 55W (SINGLE)
- COMPONENTE LED CHIP DI ELEVATA EFFICIENZA E QUALITÀ, STUDIATO SPECIFICAMENTE PER KIT A LED
- PRODOTTO IN ALLUMINIO
- DOTATO DI VENTOLA DI RAFFREDDAMENTO DI ULTIMA GENERAZIONE
- 9-32VOLT DC
- WATERPROOF: IP68
- 12000LM (LUMEN)
- TEMPERATURA COLORE: 6700K
- LIFETIME: >30.000 ORE
- TEMPERATURA OPERATIVA: DA -50°C A +90°C
- LIGHT SOURCE MODEL: G-XP X3 CUSTOMIZED



ART. 40401 H4
ART. 40423 H19



LED HEADLIGHTS SET (2 PCS.)

- LED POWER: 55W (HIGH/LOW)
- HOUSING MATERIAL: AVIATION ALUMINIUM, RED COPPER
- LAST GENERATION COOLING FAN
- 9-32VOLT DC
- WATERPROOF: IP68
- 12000LM (LUMEN)
- COLOR TEMPERATURE: 6700K
- LIFETIME: >30.000 HOURS
- OPERATING TEMPERATURE: DA -50°C A +90°C
- LIGHT SOURCE MODEL: G-XP X3 CUSTOMIZED

KIT FARI A LED (COMPOSTO DA 2 PEZZI)

- LED POWER: 55W (HIGH/LOW)
- COMPONENTE LED CHIP DI ELEVATA EFFICIENZA E QUALITÀ, STUDIATO SPECIFICAMENTE PER KIT A LED
- PRODOTTO IN ALLUMINIO
- DOTATO DI VENTOLA DI RAFFREDDAMENTO DI ULTIMA GENERAZIONE
- 9-32VOLT DC
- WATERPROOF: IP68
- 12000LM (LUMEN)
- TEMPERATURA COLORE: 6700K
- LIFETIME: >30.000 ORE
- TEMPERATURA OPERATIVA: DA -50°C A +90°C
- LIGHT SOURCE MODEL: G-XP X3 CUSTOMIZED

ART. 40403



LED HEADLIGHTS SET (2 PCS.)

- LED POWER: 55W (SINGLE)
- HOUSING MATERIAL: AVIATION ALUMINIUM, RED COPPER
- LAST GENERATION COOLING FAN
- 9-32VOLT DC
- WATERPROOF: IP68
- 12000LM (LUMEN)
- COLOR TEMPERATURE: 6700K
- LIFETIME: >30.000 HOURS
- OPERATING TEMPERATURE: DA -50°C A +90°C
- LIGHT SOURCE MODEL: G-XP X3 CUSTOMIZED

KIT FARI A LED (COMPOSTO DA 2 PEZZI)

- LED POWER: 55W (SINGLE)
- COMPONENTE LED CHIP DI ELEVATA EFFICIENZA E QUALITÀ, STUDIATO SPECIFICAMENTE PER KIT A LED
- PRODOTTO IN ALLUMINIO
- DOTATO DI VENTOLA DI RAFFREDDAMENTO DI ULTIMA GENERAZIONE
- 9-32VOLT DC
- WATERPROOF: IP68
- 12000LM (LUMEN)
- TEMPERATURA COLORE: 6700K
- LIFETIME: >30.000 ORE
- TEMPERATURA OPERATIVA: DA -50°C A +90°C
- LIGHT SOURCE MODEL: G-XP X3 CUSTOMIZED

ART. 40406



LED HEADLIGHTS SET (2 PCS.)

- LED POWER: 55W (SINGLE)
- HOUSING MATERIAL: AVIATION ALUMINIUM, RED COPPER
- LAST GENERATION COOLING FAN
- 9-32VOLT DC
- WATERPROOF: IP68
- 12000LM (LUMEN)
- COLOR TEMPERATURE: 6700K
- LIFETIME: >30.000 HOURS
- OPERATING TEMPERATURE: DA -50°C A +90°C
- LIGHT SOURCE MODEL: G-XP X3 CUSTOMIZED

KIT FARI A LED (COMPOSTO DA 2 PEZZI)

- LED POWER: 55W (SINGLE)
- COMPONENTE LED CHIP DI ELEVATA EFFICIENZA E QUALITÀ, STUDIATO SPECIFICAMENTE PER KIT A LED
- PRODOTTO IN ALLUMINIO
- DOTATO DI VENTOLA DI RAFFREDDAMENTO DI ULTIMA GENERAZIONE
- 9-32VOLT DC
- WATERPROOF: IP68
- 12000LM (LUMEN)
- TEMPERATURA COLORE: 6700K
- LIFETIME: >30.000 ORE
- TEMPERATURA OPERATIVA: DA -50°C A +90°C
- LIGHT SOURCE MODEL: G-XP X3 CUSTOMIZED



**SUPER
CANBUS
55 WATT**

**18.000
LUMEN
PER LAMPADA**



**INNOVATIVA VENTOLA
DI RAFFREDDAMENTO**

**55 WATT CAN BUS
ULTIMA GENERAZIONE**

ALUMINUM LIGHT BODY



ART. 40452



H7

LED HEADLIGHTS SET (2 PCS.)

- LED POWER: 55W (SINGLE)
- HOUSING MATERIAL: AVIATION ALUMINUM, RED COPPER
- LAST GENERATION COOLING FAN
- 12 VOLT DC
- WATERPROOF: IP68
- 18000LM (LUMEN)
- COLOR TEMPERATURE: 6000K
- LIFETIME: >30.000 HOURS
- OPERATING TEMPERATURE: DA -50°C A +90°C
- LIGHT SOURCE MODEL: G-XP X3 CUSTOMIZED

KIT FARI A LED (COMPOSTO DA 2 PEZZI)

- LED POWER: 55W (SINGLE)
- COMPONENTE LED CHIP DI ELEVATA EFFICIENZA E QUALITÀ, STUDIATO SPECIFICAMENTE PER KIT A LED
- PRODOTTO IN ALLUMINIO
- DOTATO DI VENTOLA DI RAFFREDDAMENTO DI ULTIMA GENERAZIONE
- 12 VOLT DC
- WATERPROOF: IP68
- 18000LM (LUMEN)
- TEMPERATURA COLORE: 6000K
- LIFETIME: >30.000 ORE
- TEMPERATURA OPERATIVA: DA -50°C A +90°C
- LIGHT SOURCE MODEL: G-XP X3 CUSTOMIZED

ART. 40451



H4

**MINI
NO ERROR**

LED HEADLIGHTS SET (2 PCS.)

- LED POWER: 55W (HIGH/LOW)
- HOUSING MATERIAL: AVIATION ALUMINUM, RED COPPER
- LAST GENERATION COOLING FAN
- 12 VOLT DC
- WATERPROOF: IP68
- 18000LM (LUMEN)
- COLOR TEMPERATURE: 6000K
- LIFETIME: >30.000 HOURS
- OPERATING TEMPERATURE: DA -50°C A +90°C
- LIGHT SOURCE MODEL: G-XP X3 CUSTOMIZED

KIT FARI A LED (COMPOSTO DA 2 PEZZI)

- LED POWER: 55W (HIGH/LOW)
- COMPONENTE LED CHIP DI ELEVATA EFFICIENZA E QUALITÀ, STUDIATO SPECIFICAMENTE PER KIT A LED
- PRODOTTO IN ALLUMINIO
- DOTATO DI VENTOLA DI RAFFREDDAMENTO DI ULTIMA GENERAZIONE
- 12 VOLT DC
- WATERPROOF: IP68
- 18000LM (LUMEN)
- TEMPERATURA COLORE: 6000K
- LIFETIME: >30.000 ORE
- TEMPERATURA OPERATIVA: DA -50°C A +90°C
- LIGHT SOURCE MODEL: G-XP X3 CUSTOMIZED

ART. 40453



H11

LED HEADLIGHTS SET (2 PCS.)

- LED POWER: 55W (SINGLE)
- HOUSING MATERIAL: AVIATION ALUMINUM, RED COPPER
- LAST GENERATION COOLING FAN
- 12 VOLT DC
- WATERPROOF: IP68
- 18000LM (LUMEN)
- COLOR TEMPERATURE: 6000K
- LIFETIME: >30.000 HOURS
- OPERATING TEMPERATURE: DA -50°C A +90°C
- LIGHT SOURCE MODEL: G-XP X3 CUSTOMIZED

KIT FARI A LED (COMPOSTO DA 2 PEZZI)

- LED POWER: 55W (SINGLE)
- COMPONENTE LED CHIP DI ELEVATA EFFICIENZA E QUALITÀ, STUDIATO SPECIFICAMENTE PER KIT A LED
- PRODOTTO IN ALLUMINIO
- DOTATO DI VENTOLA DI RAFFREDDAMENTO DI ULTIMA GENERAZIONE
- 12 VOLT DC
- WATERPROOF: IP68
- 18000LM (LUMEN)
- TEMPERATURA COLORE: 6000K
- LIFETIME: >30.000 ORE
- TEMPERATURA OPERATIVA: DA -50°C A +90°C
- LIGHT SOURCE MODEL: G-XP X3 CUSTOMIZED



LENTICOLARE

IL KIT A LED DELLA SERIE LENTICOLARE È STUDIATO SPECIFICAMENTE PER DARE LA MASSIMA ILLUMINAZIONE SUI FARI LENTICOLARI, PERTANTO È SCONSIGLIATA L'INSTALLAZIONE SU FARI SPROVVISTI DILENTE.



10.000 LUMEN
PER LAMPADA

CANBUS NO ERROR

ILLUMINAZIONE A 360°

48 WATT CAN BUS
ULTIMA GENERAZIONE

ALUMINUM
LIGHT BODY



ART. 40902A H7

LENTICOLARE
10.000 LUMEN



LED HEADLIGHTS SET LENTICOLARE (LENS) (2 PCS.)

- LED POWER: 48W (SINGLE)
- COMPONENTE LED CHIP DI ELEVATA EFFICIENZA E QUALITÀ, STUDIATO SPECIFICAMENTE PER KIT A LED
- PRODOTTO IN ALLUMINIO 6063
- DOPPIO DISSIPATORE DEL CALORE CON VENTOLA
- DC 9V-32V
- WATERPROOF: IP67
- 10000LM (LUMEN)
- TEMPERATURA COLORE: 6000K
- LIFETIME: >30.000 ORE
- TEMPERATURA OPERATIVA: DA -50°C A +90°C
- ANGOLO FASCIO D'ILLUMINAZIONE REGOLABILE A 360°

ART. 40903A H11

LENTICOLARE
10.000 LUMEN



LED HEADLIGHTS SET LENTICOLARE (LENS) (2 PCS.)

- LED POWER: 48W (SINGLE)
- COMPONENTE LED CHIP DI ELEVATA EFFICIENZA E QUALITÀ, STUDIATO SPECIFICAMENTE PER KIT A LED
- PRODOTTO IN ALLUMINIO 6063
- DOPPIO DISSIPATORE DEL CALORE CON VENTOLA
- DC 9V-32V
- WATERPROOF: IP67
- 10000LM (LUMEN)
- TEMPERATURA COLORE: 6000K
- LIFETIME: >30.000 ORE
- TEMPERATURA OPERATIVA: DA -50°C A +90°C
- ANGOLO FASCIO D'ILLUMINAZIONE REGOLABILE A 360°

ART. 40904A HB3-9005

LENTICOLARE
10.000 LUMEN



LED HEADLIGHTS SET LENTICOLARE (LENS) (2 PCS.)

- LED POWER: 48W (SINGLE)
- COMPONENTE LED CHIP DI ELEVATA EFFICIENZA E QUALITÀ, STUDIATO SPECIFICAMENTE PER KIT A LED
- PRODOTTO IN ALLUMINIO 6063
- DOPPIO DISSIPATORE DEL CALORE CON VENTOLA
- DC 9V-32V
- WATERPROOF: IP67
- 10000LM (LUMEN)
- TEMPERATURA COLORE: 6000K
- LIFETIME: >30.000 ORE
- TEMPERATURA OPERATIVA: DA -50°C A +90°C
- ANGOLO FASCIO D'ILLUMINAZIONE REGOLABILE A 360°

ART. 40905A HIR2-9012

LENTICOLARE
10.000 LUMEN



LED HEADLIGHTS SET LENTICOLARE (LENS) (2 PCS.)

- LED POWER: 48W (SINGLE)
- COMPONENTE LED CHIP DI ELEVATA EFFICIENZA E QUALITÀ, STUDIATO SPECIFICAMENTE PER KIT A LED
- PRODOTTO IN ALLUMINIO 6063
- DOPPIO DISSIPATORE DEL CALORE CON VENTOLA
- DC 9V-32V
- WATERPROOF: IP67
- 10000LM (LUMEN)
- TEMPERATURA COLORE: 6000K
- LIFETIME: >30.000 ORE
- TEMPERATURA OPERATIVA: DA -50°C A +90°C
- ANGOLO FASCIO D'ILLUMINAZIONE REGOLABILE A 360°

ART. 40906A H1

LENTICOLARE
10.000 LUMEN



LED HEADLIGHTS SET LENTICOLARE (LENS) (2 PCS.)

- LED POWER: 48W (SINGLE)
- COMPONENTE LED CHIP DI ELEVATA EFFICIENZA E QUALITÀ, STUDIATO SPECIFICAMENTE PER KIT A LED
- PRODOTTO IN ALLUMINIO 6063
- DOPPIO DISSIPATORE DEL CALORE CON VENTOLA
- DC 9V-32V
- WATERPROOF: IP67
- 10000LM (LUMEN)
- TEMPERATURA COLORE: 6000K
- LIFETIME: >30.000 ORE
- TEMPERATURA OPERATIVA: DA -50°C A +90°C
- ANGOLO FASCIO D'ILLUMINAZIONE REGOLABILE A 360°



LENTICOLARE

**SUPER
CANBUS**
55 WATT STABILI

**18.000
LUMEN**
PER LAMPADA



ILLUMINAZIONE A 360°

ART. 40922 H7

LENTICOLARE 18.000 LUMEN PER LAMPADA

LED HEADLIGHTS SET LENTICOLARE (LENS) (2 PCS.)

- LED POWER: 55W (SINGLE)
- COMPONENTE LED CHIP DI ELEVATA EFFICIENZA E QUALITÀ, STUDIATO SPECIFICAMENTE PER KIT A LED
- PRODOTTO IN ALLUMINIO 6063
- DOPPIO DISSIPATORE DEL CALORE CON VENTOLA
- DC 12 VOLT
- WATERPROOF: IP67
- 18000LM (LUMEN)
- TEMPERATURA COLORE: 6000K
- LIFETIME: >30.000 ORE
- TEMPERATURA OPERATIVA: DA -50°C A +90°C
- ANGOLO FASCIO D'ILLUMINAZIONE REGOLABILE A 360°

ART. 40923 H11

LENTICOLARE 18.000 LUMEN PER LAMPADA

LED HEADLIGHTS SET LENTICOLARE (LENS) (2 PCS.)

- LED POWER: 55W (SINGLE)
- COMPONENTE LED CHIP DI ELEVATA EFFICIENZA E QUALITÀ, STUDIATO SPECIFICAMENTE PER KIT A LED
- PRODOTTO IN ALLUMINIO 6063
- DOPPIO DISSIPATORE DEL CALORE CON VENTOLA
- DC 12 VOLT
- WATERPROOF: IP67
- 18000LM (LUMEN)
- TEMPERATURA COLORE: 6000K
- LIFETIME: >30.000 ORE
- TEMPERATURA OPERATIVA: DA -50°C A +90°C
- ANGOLO FASCIO D'ILLUMINAZIONE REGOLABILE A 360°

ART. 40924 HB3-9005

LENTICOLARE 18.000 LUMEN PER LAMPADA

LED HEADLIGHTS SET LENTICOLARE (LENS) (2 PCS.)

- LED POWER: 55W (SINGLE)
- COMPONENTE LED CHIP DI ELEVATA EFFICIENZA E QUALITÀ, STUDIATO SPECIFICAMENTE PER KIT A LED
- PRODOTTO IN ALLUMINIO 6063
- DOPPIO DISSIPATORE DEL CALORE CON VENTOLA
- DC 12 VOLT
- WATERPROOF: IP67
- 18000LM (LUMEN)
- TEMPERATURA COLORE: 6000K
- LIFETIME: >30.000 ORE
- TEMPERATURA OPERATIVA: DA -50°C A +90°C
- ANGOLO FASCIO D'ILLUMINAZIONE REGOLABILE A 360°

ART. 40925 HIR2-9012

LENTICOLARE 18.000 LUMEN PER LAMPADA

LED HEADLIGHTS SET LENTICOLARE (LENS) (2 PCS.)

- LED POWER: 55W (SINGLE)
- COMPONENTE LED CHIP DI ELEVATA EFFICIENZA E QUALITÀ, STUDIATO SPECIFICAMENTE PER KIT A LED
- PRODOTTO IN ALLUMINIO 6063
- DOPPIO DISSIPATORE DEL CALORE CON VENTOLA
- DC 12 VOLT
- WATERPROOF: IP67
- 18000LM (LUMEN)
- TEMPERATURA COLORE: 6000K
- LIFETIME: >30.000 ORE
- TEMPERATURA OPERATIVA: DA -50°C A +90°C
- ANGOLO FASCIO D'ILLUMINAZIONE REGOLABILE A 360°

ART. 40926 H1

LENTICOLARE 18.000 LUMEN PER LAMPADA

LED HEADLIGHTS SET LENTICOLARE (LENS) (2 PCS.)

- LED POWER: 55W (SINGLE)
- COMPONENTE LED CHIP DI ELEVATA EFFICIENZA E QUALITÀ, STUDIATO SPECIFICAMENTE PER KIT A LED
- PRODOTTO IN ALLUMINIO 6063
- DOPPIO DISSIPATORE DEL CALORE CON VENTOLA
- DC 12 VOLT
- WATERPROOF: IP67
- 18000LM (LUMEN)
- TEMPERATURA COLORE: 6000K
- LIFETIME: >30.000 ORE
- TEMPERATURA OPERATIVA: DA -50°C A +90°C
- ANGOLO FASCIO D'ILLUMINAZIONE REGOLABILE A 360°

CUSTOM LINE. PLUG AND PLAY.



I KIT A LED CUSTOM LINE PERMETTONO DI SOSTITUIRE LE LAMPADRE ORIGINALI XENON IN LAMPADRE LED SENZA ALCUNA MODIFICA, UTILIZZANDO I CONNETTORI ORIGINALI. NESSUNA SEGNALAZIONE DI ERRORE.

**AUMENTO LUMINOSITÀ:
+150%**

**DA XENON ORIGINALE
A LED 6000 LM**

ART. 40930A

LENTICOLARE



D1S D1R

PLUG AND PLAY
(CONNETTORE ORIGINALE,
SENZA MODIFICARE IMPIANTO)

CUSTOM LED HEADLIGHTS SET (2 PCS.)

- PLUG AND PLAY (CONNETTORE ORIGINALE, SENZA MODIFICARE IMPIANTO)
- COLOR: 6000K
- CONTINUOUS POWER: 35W
- MAX OPERATING TEMPERATURE: 90°
- MINIMUM OPERATING TEMPERATURE: -50°
- LUMEN: 6000LM
- HEAT DISSIPATION SYSTEM: TURBINE FUN
- HEAT DISSIPATION MATERIAL: ALUMINIUM
- DIMENSIONS: COME ORIGINALE

ART. 40932A

LENTICOLARE



D3S D3R

PLUG AND PLAY
(CONNETTORE ORIGINALE,
SENZA MODIFICARE IMPIANTO)

CUSTOM LED HEADLIGHTS SET (2 PCS.)

- PLUG AND PLAY (CONNETTORE ORIGINALE, SENZA MODIFICARE IMPIANTO)
- COLOR: 6000K
- CONTINUOUS POWER: 35W
- MAX OPERATING TEMPERATURE: 90°
- MINIMUM OPERATING TEMPERATURE: -50°
- LUMEN: 6000LM
- HEAT DISSIPATION SYSTEM: TURBINE FUN
- HEAT DISSIPATION MATERIAL: ALUMINIUM
- DIMENSIONS: COME ORIGINALE

ART. 40931A

LENTICOLARE



D2S D2R

PLUG AND PLAY
(CONNETTORE ORIGINALE,
SENZA MODIFICARE IMPIANTO)

CUSTOM LED HEADLIGHTS SET (2 PCS.)

- PLUG AND PLAY (CONNETTORE ORIGINALE, SENZA MODIFICARE IMPIANTO)
- COLOR: 6000K
- CONTINUOUS POWER: 35W
- MAX OPERATING TEMPERATURE: 90°
- MINIMUM OPERATING TEMPERATURE: -50°
- LUMEN: 6000LM
- HEAT DISSIPATION SYSTEM: TURBINE FUN
- HEAT DISSIPATION MATERIAL: ALUMINIUM
- DIMENSIONS: COME ORIGINALE

ART. 40933

LENTICOLARE



D4S D4R

PLUG AND PLAY
(CONNETTORE ORIGINALE,
SENZA MODIFICARE IMPIANTO)

CUSTOM LED HEADLIGHTS SET (2 PCS.)

- PLUG AND PLAY (CONNETTORE ORIGINALE, SENZA MODIFICARE IMPIANTO)
- COLOR: 6000K
- CONTINUOUS POWER: 35W
- MAX OPERATING TEMPERATURE: 90°
- MINIMUM OPERATING TEMPERATURE: -50°
- LUMEN: 6000LM
- HEAT DISSIPATION SYSTEM: TURBINE FUN
- HEAT DISSIPATION MATERIAL: ALUMINIUM
- DIMENSIONS: COME ORIGINALE

ART. 40934A

LENTICOLARE



D5S

PLUG AND PLAY
(CONNETTORE ORIGINALE,
SENZA MODIFICARE IMPIANTO)

CUSTOM LED HEADLIGHTS SET (2 PCS.)

- PLUG AND PLAY (CONNETTORE ORIGINALE, SENZA MODIFICARE IMPIANTO)
- COLOR: 6000K
- CONTINUOUS POWER: 45W
- MAX OPERATING TEMPERATURE: 90°
- MINIMUM OPERATING TEMPERATURE: -50°
- LUMEN: 6000LM
- HEAT DISSIPATION SYSTEM: TURBINE FUN
- HEAT DISSIPATION MATERIAL: ALUMINIUM
- DIMENSIONS: COME ORIGINALE

ART. 40935

LENTICOLARE



D8S D8R

PLUG AND PLAY
(CONNETTORE ORIGINALE,
SENZA MODIFICARE IMPIANTO)

CUSTOM LED HEADLIGHTS SET (2 PCS.)

- PLUG AND PLAY (CONNETTORE ORIGINALE, SENZA MODIFICARE IMPIANTO)
- COLOR: 6000K
- CONTINUOUS POWER: 25W
- MAX OPERATING TEMPERATURE: 90°
- MINIMUM OPERATING TEMPERATURE: -50°
- LUMEN: 6000LM
- HEAT DISSIPATION SYSTEM: TURBINE FUN
- HEAT DISSIPATION MATERIAL: ALUMINIUM
- DIMENSIONS: COME ORIGINALE

KIT A LED CUSTOM LINE PLUG AND PLAY H15

KIT A LED CUSTOM LINE PLUG AND PLAY

ART. 40558B

H15

ALTA LUMINOSITÀ
6000 LUMEN
per lampada



CANBUS
NO ERROR

KIT FARI A LED PLUG AND PLAY (COMPOSTO DA 2 PEZZI)

- LED POWER: 30W (HIGH/LOW)
- COMPONENTE LED CHIP DI ELEVATA EFFICIENZA E QUALITÀ, STUDIATO SPECIFICAMENTE PER KIT A LED
- PRODOTTO IN ALLUMINIO
- DOTATO DI DISSIPATORE DEL CALORE
- DC 9V-16V
- INPUT 1.2A±0.1A
- WATERPROOF: IP67
- 5000LM (LUMEN)
- TEMPERATURA COLORE: 6000K
- LIFETIME: >10.000 ORE
- TEMPERATURA OPERATIVA: DA -50°C A +90°C



Car	Model	Year	High beam / DRL
	A260 imported	2012-2013	H15
	A180 imported	2013	
	A45 AMG imported	2011-2017	
	Vito	2015	
	GLK200	2014	
	GLK260	2014	
GLK300	2014-2016		
	Landrover Discovery Sport	2016	
	BMW 2 series 220i	2015	
	BMW 2 series M235i	2014	
	A6 imported	2012-2015	
	A3	2014-2015	
	Q7	2014-2016	
	Ford Edge	2015-2017	
	Ford Explorer	2016	
	VW Golf6	2009-2010	
	Multivan	2012-2016	
	Touran	2011-2015	
	Golf jialv	2016	
	Golf7	2014-2016	
	Toureg	2011-2012	



ART. 40617A

PLUG AND PLAY
(CONNETTORE ORIGINALE, SENZA MODIFICARE IMPIANTO)

KIT A LED SPECIFICO
PER VOLKSWAGEN
GOLF VII

NON NECESSITA DI
ADATTATORI, NON NECESSITA
DI RESISTENZE.
SENZA CABLAGGIO, SI
INSTALLA COME UNA
NORMALE LAMPADINA.

ALTA LUMINOSITÀ
8000 LUMEN
per lampada

CANBUS SPECIFICO GOLF VII
ULTIMA GENERAZIONE

ALUMINUM
LIGHT BODY

WHITE 6000K

INSTALLAZIONE
SEMPLIFICATA

NO ERROR

TABELLA DI COMPATIBILITÀ

QUESTO PRODOTTO PUÒ ESSERE INSTALLATO SUI SEGUENTI VEICOLI

MARCA	MODELLO	ANNO
VOLKSWAGEN	ALLTRACK	2017
VOLKSWAGEN	E-GOLF	2015~2017
VOLKSWAGEN	EOS	2012~2016
VOLKSWAGEN	GOLF	2010~2017
VOLKSWAGEN	GOLF R	2012~2013, 2015~2017
VOLKSWAGEN	GTI	2010~2017
VOLKSWAGEN	SPORTWAGEN	2010~2014
VOLKSWAGEN	TIGUAN	2012~2017
MERCEDES-BENZ	VITO	2010~2012



KIT A LED "TRUCK LINE" SPECIFICO TRUCK 24 VOLT CAN BUS

**PARABOLA &
LENTICOLARE**



• IVECO STRALIS EURO 4/5/6 NO PROBLEM CON FILTRO 40259

8000 LUMEN
PER LAMPADA

ART. 40752A - H7
ART. 40751 - H4
ART. 40756A - H1

➤ **GAMMA COMPLETA LAMPAD E 24V TRUCK VEDI PAGINA 44** ◀

ART. 40252 (12 VOLT) H7



DIGITAL LED WARNING CANCELLER (H7)
FILTRO RESISTENZA PER KIT LED H7

ART. 41262 H7

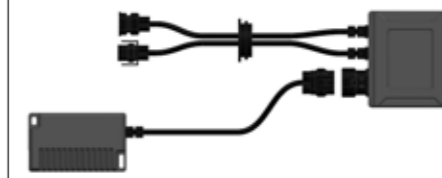

SUPER CANCELLER (H7)

ART. 40251
H1-H3



DIGITAL LED WARNING CANCELLER (H1 H3)
FILTRO RESISTENZA PER KIT LED H1 H3

- CANBUS NO ERROR 12V 30W

ART. 40255



DIGITAL LED WARNING CANCELLER (H4)
FILTRO RESISTENZA PER KIT LED H4

- BI-LED
- CANBUS NO ERROR 12V 40/40W

ART. 40256



NO ERROR WARNING CANCELLER (H7)
RESISTENZA PER LAMPADA LED H7

- 50W
- 6 OHM

ART. 40253

H8-H9-H11

ART. 40254

HB3-9005-HB4-9006-H10 - HIR2



DIGITAL LED WARNING CANCELLER (H8 H9 H11 HB3 9005 HB4 9006 H10 HIR2)
FILTRO RESISTENZA PER KIT LED (H8 H9 H11 HB3 9005 HB4 9006 H10 HIR2)

- CANBUS NO ERROR 12V 40W

ART. 40257

H8-H9-H11



NO ERROR WARNING CANCELLER (H8 H9 H11)
RESISTENZA PER LAMPADA LED H8 H9 H11

- 50W
- 6 OHM

ART. 40260

H15



DIGITAL LED WARNING CANCELLER (H15)
FILTRO RESISTENZA PER KIT LED (H15)

- CANBUS NO ERROR 12V 40W

ART. 40258

HB3-9005
HB4-9006
H10 - HIR2



NO ERROR WARNING CANCELLER (HB3 9005 HB4 9006 H10 HIR2)
RESISTENZA PER LAMPADA LED HB3 9005 HB4 9006 H10 HIR2)

- 50W
- 6 OHM

ART. 40215

**KIT LED ADAPTER (H7)
PORTALAMPADA PER KIT LED H7**

- ALFA ROMEO MITO
- AUDI A6
- FORD KUGA
- RENAULT MEGANE 4
- VW SAGITAR,
PASSAT 3C, TOURAN
- FORO 23 mm



ART. 40210

**KIT LED ADAPTER (H7)
PORTALAMPADA PER KIT LED H7**

- FIAT NUOVA 500, 500x, 500L
- FORD FOCUS
- OPEL CORSA D (con piccola modifica)
- LAND ROVER DISCOVERY

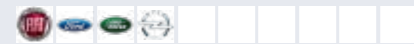

ART. 40214

**KIT LED ADAPTER (H7)
PORTALAMPADA PER KIT LED H7**

- FORD MONDEO, FOCUS, FIESTA
- ANABBAGLIANTE

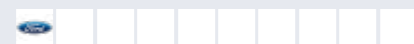

ART. 40208

**KIT LED ADAPTER (H1)
PORTALAMPADA PER KIT LED H1**

- FORD FOCUS, MONDEO, FIESTA
- ABBAGLIANTE



ART. 40209

**KIT LED ADAPTER (H7)
PORTALAMPADA PER KIT LED H7**

- FORD FOCUS, MONDEO, FIESTA
- ANABBAGLIANTE
- FORO 24 mm



ART. 40207

**KIT LED ADAPTER (H7)
PORTALAMPADA PER KIT LED H7**

- CITROEN C5, DS5,
DS6, C3 PICASSO
- FORD MONDEO
- PEUGEOT 508, 2008,
3008
- FORO 23 mm



ART. 40227

**KIT LED ADAPTER (H7)
PORTALAMPADA PER KIT LED H7**

- HYUNDAI TUCSON 2018, VELOSTER COUPE,
SONATA, SANTA FE
- KIA K3, K4, K5, GREA, SORENTO, SPORTAGE, GRIEG
- FORO 23 mm



ART. 40203

**KIT LED ADAPTER (H7)
PORTALAMPADA PER KIT LED H7**

- AUDI
- BMW
- MERCEDES CLASSE B, C, GLA, GL
- FORO 22 mm

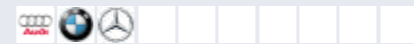

ART. 40204

**KIT LED ADAPTER (H7)
PORTALAMPADA PER KIT LED H7**

- UNIVERSALE
- AUDI A3, A4L, A6L
- BMW SERIE 5, X5
- BUICK REGAL,
EXCELLE, LACROSS
- MERCEDES
CLASSE E, ML
- NISSAN QASHQAI
- OPEL ASTRA
- RENAULT MASTER
- VW NEW BORA



ART. 40205

**KIT LED ADAPTER (H7)
PORTALAMPADA PER KIT LED H7**

- MERCEDES SPRINTER
- SEAT ALHAMBRA 2012
- VW GOLF VI, VII, SCIROCCO
- FORO 22 mm

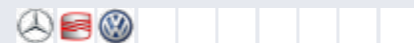

ART. 40213

**KIT LED ADAPTER (H7)
PORTALAMPADA PER KIT LED H7**

- MG GS
- SKODA OCTAVIA
- VW POLO
- FORO 24 mm

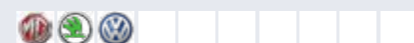

ART. 40211

KIT LED ADAPTER (H7)

**SU QUESTE AUTO SI SCONSIGLIA L'UTILIZZO DI QUESTO ADATTATORE,
MEGLIO UTILIZZARE IL KIT A LED SPECIFICO ART. 40617 A PAGINA 4**

- MERCEDES SPRINTER
- SEAT ALHAMBRA 2012
- VW GOLF VI, VII, SHARAN, TOURAN, SCIROCCO,
POLO 2013
- AUTO ALIMENTAZIONE CON SPINA
- FORO 23 mm



ART. 40206

**KIT LED ADAPTER (H7)
PORTALAMPADA PER KIT LED H7**

- VW JETTA, GOLF IV, GOLF V, TOURAN, TIGUAN



ART. 40216

**KIT LED ADAPTER (H7)
PORTALAMPADA PER KIT LED H7**

- HONDA CRV
- MAZDA
- OPEL ASTRA G,
ZAFIRA
- FORO 28 mm



ART. 40217

**KIT LED ADAPTER (H7)
PORTALAMPADA PER KIT LED H7**

- HYUNDAI NUOVO TUCSON, LAVITA, ELANTRA,
MISTRA
- KIA



ART. 40218

**KIT LED ADAPTER (H1)
PORTALAMPADA PER KIT LED H1**

- DONGFENG FENGXING
- HONDA ODYSSEY, GEELY, MOTO GL EAGLET,
SOUEAST, V3, V5, V6
- FORO 19 mm



ART. 40225

**KIT LED ADAPTER (H7)
PORTALAMPADA PER KIT LED H7**

- VW TOURAN
- FORD FIESTA
- SKODA OCTAVIA
- OPEL
- SAAB



ART. 40212

**KIT LED ADAPTER (H7)
PORTALAMPADA PER KIT LED H7**

- HYUNDAI I30 SW 2012
- KIA K5

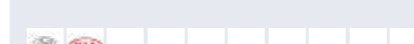

ART. 40219

**KIT LED ADAPTER (H7)
PORTALAMPADA PER KIT LED H7**

- HONDA CRV
- MAZDA
- OPEL
- FORO 24 mm



ART. 40220

**OLD CAR BULB ADAPTER
ADATTATORE DA ATTACCO H4 HS1
A H5 R2 G40 PORTALAMPADA KIT
XENON E LED PER AUTO D'EPOCA**

- KIT RIDUTTORE ADATTATORE CONVERTITORE DA
ATTACCO H4 HS1 P43T A H5 R2 G40 P45T
- CON QUESTI ADATTATORI POTETE INSTALLARE
KIT XENON E LED H4 NELLE VECCHIE LAMPADE
ASIMMETRICHE
- ADATTO PER AUTO D'EPOCA FIAT 500 F L R FIAT
126 FIAT 112 FIAT 600 MINI E SCOOTER ECT.
- KIT COMPRENDE 2 ADATTATORI METALLICI
PER LAMPADE ASIMMETRICHE + 2 BLOCCHI DI
METALLO

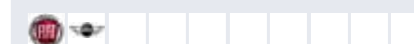

ART. 40224

**KIT LED ADAPTER (H7)
PORTALAMPADA PER KIT LED H7**

- KIA RIO, CARENS
- HYUNDAI ELANTRA, AZERA, VELOSTAR, MISTRA,
H350, SONATA
- FORO 22mm



ART. 40223

**KIT FERMAGLI IN FERRO
DI RITENUTA LAMPADE PER FANALE
(13 PEZZI)**

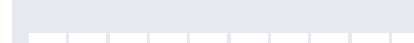

ART. 40226

**KIT LED ADAPTER (H7)
PORTALAMPADA PER KIT LED H7**

- FORD FIESTA 2019

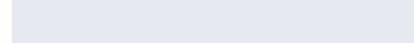

ART. 40201

**REAR COVER
RUBBER
TAPPO FORATO**

- DIAMETRO
100 mm



ART. 40221

**REAR COVER RUBBER
TAPPO CUFFIA**

- DIAMETRO
55 mm

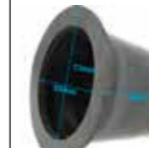

ART. 40222

**REAR COVER RUBBER
TAPPO CUFFIA**

- DIAMETRO
73 mm



**SUPER CANBUS
FIAT NO ERROR**



45 LED

**800 LM
PER LAMPADA**

ART. 41061B

45 LED - 800 LM

DOPPIO FILAMENTO



- 45 LED
- SUPER CANBUS
- H: 680±20MA - L: 80±10MA
- REVERSE POLARITY PROTECTION
- CONSTANT CURRENT IC
- SURGE VOLTAGE 18V
- 12V-16.5V
- 1157

- LAMPADA DI POSIZIONE A LED
- BAY15D - 1157 - P21W/5W
- DOPPIO FILAMENTO
- CAN BUS NO ERROR
- 12 VOLT
- 45 LED ALTA LUMINOSITA'
- 800 LUMEN
- WHITE 6500K

ART. 41060B

45 LED - 800 LM

DOPPIO FILAMENTO



- 45 LED
- SUPER CANBUS
- 680±20MA
- NO-POLARITY
- CONSTANT CURRENT IC
- SURGE VOLTAGE 18V
- 12V-16.5V
- 1156

- LAMPADA DI POSIZIONE A LED
- BA15S - 1156 - P21W
- SINGOLO FILAMENTO
- CAN BUS NO ERROR
- 12 VOLT
- 45 LED ALTA LUMINOSITA'
- 800 LUMEN
- WHITE 6500K

**SUPER CANBUS
FIAT NO ERROR**

ART. 41051B

45 LED - 800 LM

DOPPIO FILAMENTO



- 45 LED
- SUPER CANBUS
- H: 680±20MA - L: 80±10MA
- REVERSE POLARITY PROTECTION
- CONSTANT CURRENT IC
- SURGE VOLTAGE 18V
- 12V-16.5V
- 7443

- LAMPADA DI POSIZIONE A LED
- T20 - 7443 - W21W /5W
- DOPPIO FILAMENTO
- CAN BUS NO ERROR
- 12 VOLT
- 45 LED ALTA LUMINOSITA'
- 800 LUMEN
- WHITE 6500K

ART. 41050B

45 LED - 800 LM

DOPPIO FILAMENTO



- 45 LED
- SUPER CANBUS
- 680± 20MA
- NO-POLARITY
- CONSTANT CURRENT IC
- SURGE VOLTAGE 18V
- 12V-16.5V
- 7440

- LAMPADA DI POSIZIONE A LED
- T20 - 7440 - W21W
- SINGOLO FILAMENTO
- CAN BUS NO ERROR
- 12 VOLT
- 45 LED ALTA LUMINOSITA'
- 800 LUMEN
- WHITE 6500K

**SUPER CANBUS
FIAT NO ERROR**

ART. 41062A

**24 LED (3838 OSRAM)
1200 LM**

**LUCE FRECCIE
COLOR ARANCIONE**



- 24*3838 OSRAM
- LED SAMSUNG
- CANBUS
- 680± 20MA
- NO-POLARITY
- CONSTANT CURRENT IC
- SURGE VOLTAGE 18V
- 12V-16.5V
- 1156 BAU15S

- LAMPADA FRECCIE A LED
- PY21W - S25 - BAU15S
- 12V - 21W
- SINGOLO FILAMENTO
- CAN BUS NO ERROR
- 12 VOLT
- 24 LED ALTA LUMINOSITA'
- 1200LM
- LUCE ARANCIONE FRECCIE

**NON NECESSITA DI RESISTENZA.
IL TEMPO DI INTERMITTENZA RIMANE INVARIATO.**

**SUPER CANBUS
FIAT NO ERROR**

ART. 41006



**T10
W5W**

- 14 LED
- SUPER CANBUS NO ERROR
- 5 WATT
- NON-POLARITY
- CONSTANT CURRENT IC
- SURGE VOLTAGE 18V
- 12-14.5V
- 600 LM
- LAMPADA DI POSIZIONE A LED
- T10 W5W
- TUTTO VETRO
- 12 VOLT
- LUCE BIANCA FREDDA 6500K

ART. 41007

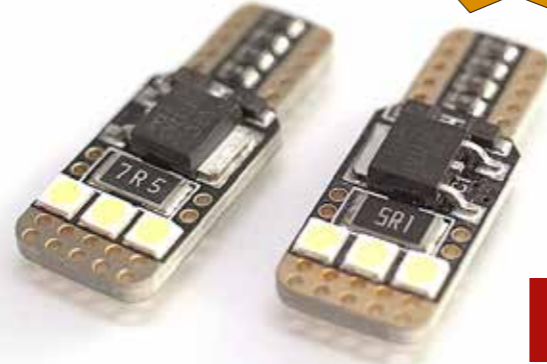

**T10
W5W**

- 6 LED
- SUPER CANBUS NO ERROR
- 5 WATT
- NON-POLARITY
- CONSTANT CURRENT IC
- SURGE VOLTAGE 18V
- 12-14.5V
- 500 LM
- LAMPADA DI POSIZIONE A LED
- T10 W5W
- TUTTO VETRO
- 12 VOLT
- LUCE BIANCA FREDDA 6500K

**SUPER CANBUS
FIAT NO ERROR**

ART. 41003

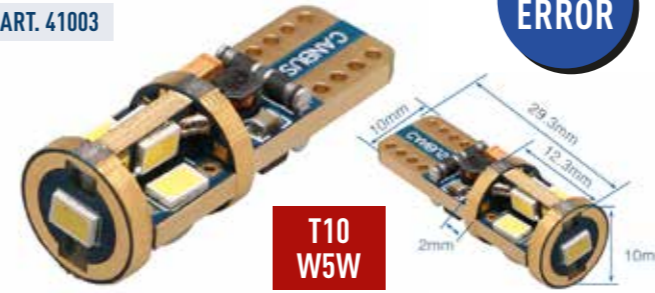

**T10
W5W**

- 9*3623SMD
- LED SAMSUNG
- SUPER CANBUS
- 250±10MA
- NON-POLARITY
- CONSTANT CURRENT IC
- SURGE VOLTAGE 18V
- 12-14.5V
- 400 LM
- WHITE 5500K
- LAMPADA DI POSIZIONE A LED
- T10 W5W
- TUTTO VETRO
- CAN BUS NO ERROR
- 12 VOLT
- LUCE BIANCA FREDDA 5500K
- 9 LED ALTA LUMINOSITA'

ART. 41130 - 31mm

ART. 41131 - 36mm



**T11
(SILURO)**

- CAN BUS
- POWER: 5W
- COLOR: WHITE
- LED QUANTITY: 6PCS
- VOLTAGE: DC10V-16V
- BEAM ANGLE: 180°
- LAMPADA DI POSIZIONE A LED
- CAN BUS NO ERROR
- 12 VOLT
- LUCE BIANCA FREDDA 5500K
- 6 LED ALTA LUMINOSITA'
- SILURO 36 MM
- USAGE: READING LIGHT, MIRROR LIGHT, LICENSE PLATE LIGHT, TRUCK LIGHT

ART. 41002

NO
ERROR

**T10
W5W**



- 15 LED SMD 4014
- CANBUS
- 250±10MA
- NON-POLARITY
- CONSTANT CURRENT IC
- SURGE VOLTAGE 18V
- 12V-14.5V
- 350 LM
- WHITE 5500K
- LAMPADA DI POSIZIONE A LED
- T10 W5W
- TUTTO VETRO
- CAN BUS NO ERROR
- 12 VOLT
- LUCE BIANCA FREDDA 5500K
- 15 LED ALTA LUMINOSITA'

ART. 41004

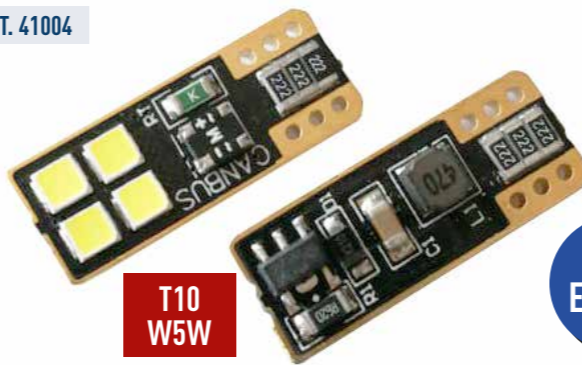

**T10
W5W**

NO
ERROR

- 4*3623SMD
- LED SAMSUNG
- SUPER CANBUS
- 250±10MA
- NON-POLARITY
- COSTANT CURRENT IC
- SURGE VOLTAGE 18V
- 12V-14.5V
- 300 LM
- WHITE 5500K
- LAMPADA DI POSIZIONE A LED
- T10 W5W
- TUTTO VETRO
- CAN BUS NO ERROR
- 12 VOLT
- LUCE BIANCA FREDDA 5500K
- 4 LED ALTA LUMINOSITA'

ART. 41132 - 39mm

NO
ERROR

**T11
(SILURO)**



- CAN BUS
- POWER: 5W
- COLOR: WHITE
- LED QUANTITY: 6PCS
- VOLTAGE: DC10V-16V
- BEAM ANGLE: 180°
- LAMPADA DI POSIZIONE A LED
- CAN BUS NO ERROR
- 12 VOLT
- LUCE BIANCA FREDDA 5500K
- 6 LED ALTA LUMINOSITA'
- SILURO 39 MM
- USAGE: READING LIGHT, MIRROR LIGHT, LICENSE PLATE LIGHT, TRUCK LIGHT

ART. 41133 - 41mm

NO
ERROR

**T11
(SILURO)**



- CAN BUS
- POWER: 5W
- COLOR: WHITE
- LED QUANTITY: 6PCS
- VOLTAGE: DC10V-16V
- BEAM ANGLE: 180°
- LAMPADA DI POSIZIONE A LED
- CAN BUS NO ERROR
- 12 VOLT
- LUCE BIANCA FREDDA 5500K
- 6 LED ALTA LUMINOSITA'
- SILURO 41 MM
- USAGE: READING LIGHT, MIRROR LIGHT, LICENSE PLATE LIGHT, TRUCK LIGHT

ART. 41005

**T10
W5W**



- 4*3623SMD
- LED SAMSUNG
- SUPER CANBUS
- 250±10MA
- NON-POLARITY
- COSTANT CURRENT IC
- SURGE VOLTAGE 18V
- 12V-14.5V
- 400 LM
- WHITE 5500K
- LAMPADA DI POSIZIONE A LED
- T10 W5W
- TUTTO VETRO
- CAN BUS NO ERROR
- 12 VOLT - 5W
- LUCE BIANCA FREDDA 5500K
- 4 LED ALTA LUMINOSITA'

NO
ERROR

LUCE
360°

ART. 41101

**T10
W5W**

NO
ERROR



- CAN BUS
- POWER: 5W
- COLOR: WHITE 5500 K
- LED QUANTITY: 6PCS
- VOLTAGE: DC10V-16V
- BEAM ANGLE: 180°
- USAGE: READING LIGHT, MIRROR LIGHT, LICENSE PLATE LIGHT, WIDTH LIGHT
- LAMPADA DI POSIZIONE A LED
- T10
- CAN BUS NO ERROR
- 12 VOLT
- LUCE BIANCA FREDDA 5500K
- 6 LED ALTA LUMINOSITA'
- W5W (TUTTO VETRO)

ART. 41155

W16W

NO
ERROR



- CAN BUS
- POWER: 15W
- COLOR: WHITE
- LED QUANTITY: 10PCS
- VOLTAGE: DC10V-16V
- BEAM ANGLE: 360°
- LAMPADA DI POSIZIONE/RETROMARCIA A LED
- CAN BUS NO ERROR
- 12 VOLT
- LUCE BIANCA FREDDA 5500K
- 10 LED ALTA LUMINOSITA'
- USAGE: READING LIGHT, MIRROR LIGHT, LICENSE PLATE LIGHT, TRUCK LIGHT

ART. 41066

**PIEDI DRITTI
T4W**

NO
ERROR

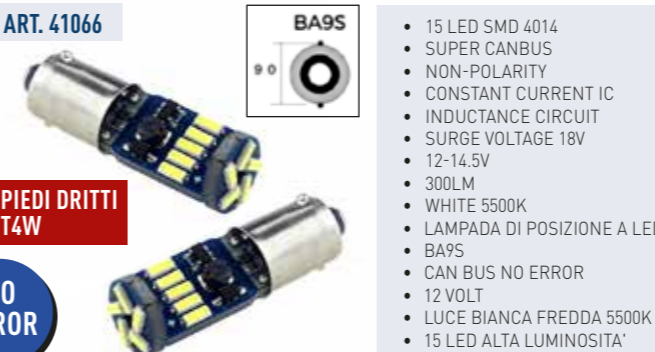

- 15 LED SMD 4014
- SUPER CANBUS
- NON-POLARITY
- CONSTANT CURRENT IC
- INDUCTANCE CIRCUIT
- SURGE VOLTAGE 18V
- 12-14.5V
- 300LM
- WHITE 5500K
- LAMPADA DI POSIZIONE A LED
- BA9S
- CAN BUS NO ERROR
- 12 VOLT
- LUCE BIANCA FREDDA 5500K
- 15 LED ALTA LUMINOSITA'

ART. 41065

**PIEDI STORTI
H6W**

NO
ERROR



- 15 LED SMD 4014
- SUPER CANBUS
- NON-POLARITY
- CONSTANT CURRENT IC
- INDUCTANCE CIRCUIT
- SURGE VOLTAGE 18V
- 12-14.5V
- 300LM
- WHITE 5500K
- LAMPADA DI POSIZIONE A LED
- BAX9S
- CAN BUS NO ERROR
- 12 VOLT
- LUCE BIANCA FREDDA 5500K
- 15 LED ALTA LUMINOSITA'

ART. 43160

12/24 Volt



LUCE FREDDA
6000K

SINGOLO FILAMENTO

- INPUT (MA): 450±20
- 12/24 VOLT
- LUMENS (LM): 800
- LED QUANTITY: 13 SMD
- PCB: ALUMINUM SUBSTRATE
- BEAM ANGLE: 360°
- LAMPADA DI POSIZIONE A LED
- USAGE: BACK-UP LIGHT, TURNING LIGHT, TAIL LIGHT
- BA15S - 1156 - P21W
- SINGOLO FILAMENTO
- CAN BUS NO ERROR
- LUCE BIANCA FREDDA 6000K

ART. 43161

12/24 Volt



LUCE FREDDA
6000K

DOPPIO FILAMENTO

- INPUT (MA): H 450±20 - L 100±20
- 12/24 VOLT
- LUMENS (LM): 800
- LED QUANTITY: 13 SMD
- PCB: ALUMINUM SUBSTRATE
- BEAM ANGLE: 360°
- LAMPADA DI POSIZIONE A LED
- USAGE: BACK-UP LIGHT, TURNING LIGHT, TAIL LIGHT
- BAY15D - 1157 - P21W/5W
- DOPPIO FILAMENTO
- CAN BUS NO ERROR
- LUCE BIANCA FREDDA 6000K

ART. 43152

12/24 Volt



LUCE FRECCE
COLOR ARANCIONE

SINGOLO FILAMENTO

- INPUT (MA): 450±20
- 12/24 VOLT
- LUMENS (LM): 800
- LED QUANTITY: 13 SMD
- PCB: ALUMINUM SUBSTRATE
- BEAM ANGLE: 360°
- LAMPADA FRECCE A LED
- USAGE: BACK-UP LIGHT, TURNING LIGHT, TAIL LIGHT
- T20 - 7440 - W21W
- SINGOLO FILAMENTO
- CAN BUS NO ERROR
- LUCE ARANCIONE FRECCE

ART. 43173

12/24 Volt



LUCE FREDDA
6000K

PSX24W

- INPUT (MA): H 450±20 - L 100±20
- 12/24 VOLT
- LUMENS (LM): 800
- LED QUANTITY: 13 SMD
- PCB: ALUMINUM SUBSTRATE
- BEAM ANGLE: 360°
- LAMPADA DI POSIZIONE A LED
- USAGE: BACK-UP LIGHT, TURNING LIGHT, TAIL LIGHT
- T20/21-5W - 7443 - W21/5W
- DOPPIO FILAMENTO
- CAN BUS NO ERROR
- LUCE BIANCA FREDDA 6000K

ART. 43150

12/24 Volt



LUCE FREDDA
6000K

SINGOLO FILAMENTO

- INPUT (MA): 450±20
- 12/24 VOLT
- LUMENS (LM): 800
- LED QUANTITY: 13 SMD
- PCB: ALUMINUM SUBSTRATE
- BEAM ANGLE: 360°
- LAMPADA DI POSIZIONE A LED
- USAGE: BACK-UP LIGHT, TURNING LIGHT, TAIL LIGHT
- T20 - 7440 - W21W
- SINGOLO FILAMENTO
- CAN BUS NO ERROR
- LUCE BIANCA FREDDA 6000K

ART. 43151

12/24 Volt



LUCE FREDDA
6000K

DOPPIO FILAMENTO

- INPUT (MA): H 450±20 - L 100±20
- 12/24 VOLT
- LUMENS (LM): 800
- LED QUANTITY: 13 SMD
- PCB: ALUMINUM SUBSTRATE
- BEAM ANGLE: 360°
- LAMPADA DI POSIZIONE A LED
- USAGE: BACK-UP LIGHT, TURNING LIGHT, TAIL LIGHT
- T20/21-5W - 7443 - W21/5W
- DOPPIO FILAMENTO
- CAN BUS NO ERROR
- LUCE BIANCA FREDDA 6000K

ART. 41174



- POWER: 28W
- INPUT (MA): 760±20
- LUMENS (LM): 760
- LED QUANTITY: 14PCS
- VOLTAGE: DC10V-16V
- PCB: ALUMINUM SUBSTRATE
- BEAM ANGLE: 360°
- USED: FRONT FOG LIGHTS
- WHITE 5500K
- LAMPADA A LED
- H11-H8
- CAN BUS NO ERROR
- 12 VOLT
- LUCE BIANCA FREDDA 5500K
- 14 LED ALTA LUMINOSITA'

LED.PROHB3C14



- POWER: 28W
- INPUT (MA): 760±20
- LUMENS (LM): 760
- LED QUANTITY: 14PCS
- VOLTAGE: DC10V-16V
- PCB: ALUMINUM SUBSTRATE
- BEAM ANGLE: 360°
- USED: FRONT FOG LIGHTS
- WHITE 5500K
- LAMPADA A LED
- HB3 9005
- CAN BUS NO ERROR
- 12 VOLT
- LUCE BIANCA FREDDA 5500K
- 14 LED ALTA LUMINOSITA'

ART. 43162

12/24 Volt



LUCE FRECCE
COLOR ARANCIONE

SINGOLO FILAMENTO

- INPUT (MA): 450±20
- 12/24 VOLT
- LUMENS (LM): 800
- LED QUANTITY: 13 SMD
- PCB: ALUMINUM SUBSTRATE
- BEAM ANGLE: 360°
- LAMPADA FRECCE A LED
- USAGE: BACK-UP LIGHT, TURNING LIGHT, TAIL LIGHT
- PY21W - S25 - BAU15S
- SINGOLO FILAMENTO
- CAN BUS NO ERROR
- LUCE ARANCIONE FRECCE

ART. 43163

12/24 Volt



LUCE POSIZIONE/STOP
COLOR ROSSO

DOPPIO FILAMENTO

- INPUT (MA): H 450±20 - L 100±20
- 12/24 VOLT
- LUMENS (LM): 800
- LED QUANTITY: 13 SMD
- PCB: ALUMINUM SUBSTRATE
- BEAM ANGLE: 360°
- LAMPADA POSIZIONE/STOP A LED
- USAGE: BACK-UP LIGHT, TURNING LIGHT, TAIL LIGHT
- BAY15D - 1157 - P21/5W
- SINGOLO FILAMENTO
- CAN BUS NO ERROR
- LUCE ROSSA POSIZIONE/STOP

LED.PROHB4C14



- POWER: 28W
- INPUT (MA): 760±20
- LUMENS (LM): 760
- LED QUANTITY: 14PCS
- VOLTAGE: DC10V-16V
- PCB: ALUMINUM SUBSTRATE
- BEAM ANGLE: 360°
- USED: FRONT FOG LIGHTS
- WHITE 5500K
- LAMPADA A LED
- HB4 9006
- CAN BUS NO ERROR
- 12 VOLT
- LUCE BIANCA FREDDA 5500K
- 14 LED ALTA LUMINOSITA'

ART. 41170 - 1 coppia

PW24W
PWY24W



- POWER: 50W
- INPUT (MA): 760±20
- LUMENS (LM): 760
- LED QUANTITY: 10 PCS CREE DA 5W
- VOLTAGE: DC10V-16V
- PCB: ALUMINUM SUBSTRATE
- BEAM ANGLE: 360°
- USED: FRONT FOG LIGHTS
- WHITE 6000K
- LAMPADA A LED
- PW24W - PWY24W
- CAN BUS NO ERROR
- 12 VOLT
- LUCE BIANCA FREDDA 6000K
- 10 LED ALTA LUMINOSITA'

ART. 41201
CAN BUS NO ERROR

NO ERROR



T10
W5W

- QUESTO MODELLO NON DA ERRORE AL COMPUTER DI BORDO
- BASE T10 W5W (TUTTO VETRO)
- UTILIZZO LUCI DI POSIZIONE, LUCI DI CORTESIA ETC ETC
- 8 LED SMD
- LUCE FRONTALE E LATERALE
- ILLUMINAZIONE BIANCO GHIACCIO 6000K - 12 VOLT

ART. 41202
CAN BUS NO ERROR

NO ERROR



T10
W5W

- QUESTO MODELLO NON DA ERRORE AL COMPUTER DI BORDO
- BASE T10 W5W (TUTTO VETRO)
- UTILIZZO LUCI DI POSIZIONE, LUCI DI CORTESIA ETC ETC - 5 GRANDI LED SMD "5050" - LUCE FRONTALE E LATERALE
- ILLUMINAZIONE BIANCO GHIACCIO 6000K
- 12 VOLT

ART. 41200 - CAN BUS NO ERROR

NO ERROR



T5
CRUSCOTTO

- LAMPADA T5 DA CRUSCOTTO
- QUESTO MODELLO NON DA ERRORE AL COMPUTER DI BORDO
- BASE T5
- UTILIZZO LUCI CRUSCOTTO
- 2 LED SMD "5050"
- ILLUMINAZIONE BIANCO GHIACCIO 6000K - 12 VOLT

ART. 41260 - CAN BUS NO ERROR

NO ERROR



- QUESTO MODELLO NON DA ERRORE AL COMPUTER DI BORDO
- NON SEGNA ERRORE SU 12V 5W
- BASE BA15S G18,5
- UTILIZZO LUCI DI POSIZIONE, LUCI DI CORTESIA, ETC ETC
- LUCI DIURNE AUDI (NO ERROR)
- 7 GRANDI LED SMD "5050"
- LUCE FRONTALE E LATERALE
- ILLUMINAZIONE BIANCO GHIACCIO 6000K - 12 VOLT - 5 WATT

ART. 41212

NO ERROR



T10
W5W

- BASE T10 W5W (TUTTO VETRO)
- UTILIZZO LUCI DI POSIZIONE, LUCI DI CORTESIA, LUCI TARGA ETC ETC - 5 LED SMD 5050
- 3 CHIP
- LUCE FRONTALE E LATERALE
- ILLUMINAZIONE BIANCO GHIACCIO 6000K.
- 12 VOLT

ART. 41213

NO ERROR



T10
W5W

- BASE T10 W5W (TUTTO VETRO)
- UTILIZZO LUCI DI POSIZIONE, LUCI DI CORTESIA ETC.
- 8 LED SMD - INTENSA LUCE FRONTALE
- ILLUMINAZIONE BIANCO GHIACCIO 6000K.
- 12 VOLT

ART. 41280

NO ERROR

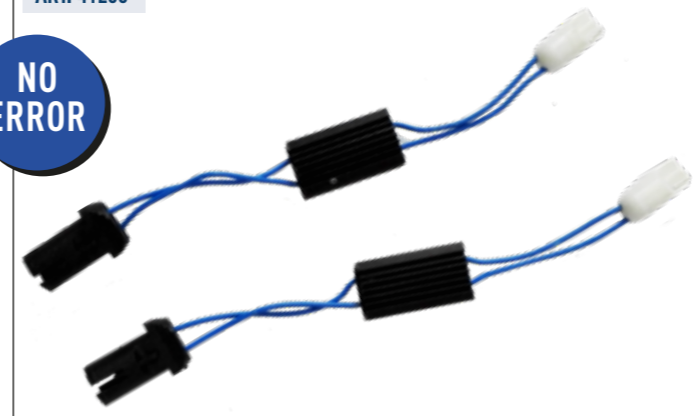

- RESISTENZE PER LAMPADINE A LED STANDARD BASE "TUTTO VETRO"
- T10 W5W
- 12 VOLT
- 1 COPPIA

ART. 41281

NO ERROR

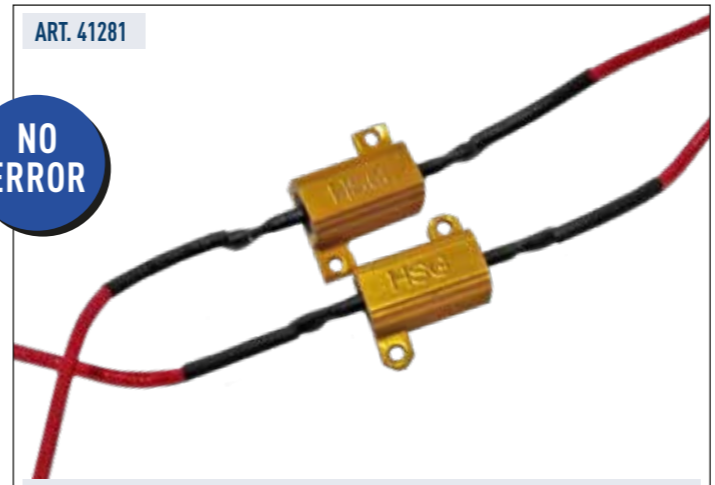

- COPPIA RESISTENZE PER SIMULARE UN CARICO DA 5 WATT A 12 VOLT

ART. 41282

NO ERROR



- COPPIA RESISTENZE PER SIMULARE UN CARICO DA 21 WATT A 12 VOLT



SCHEMA
DI COLLEGAMENTO
RESISTENZA
SPEGNI SPIA

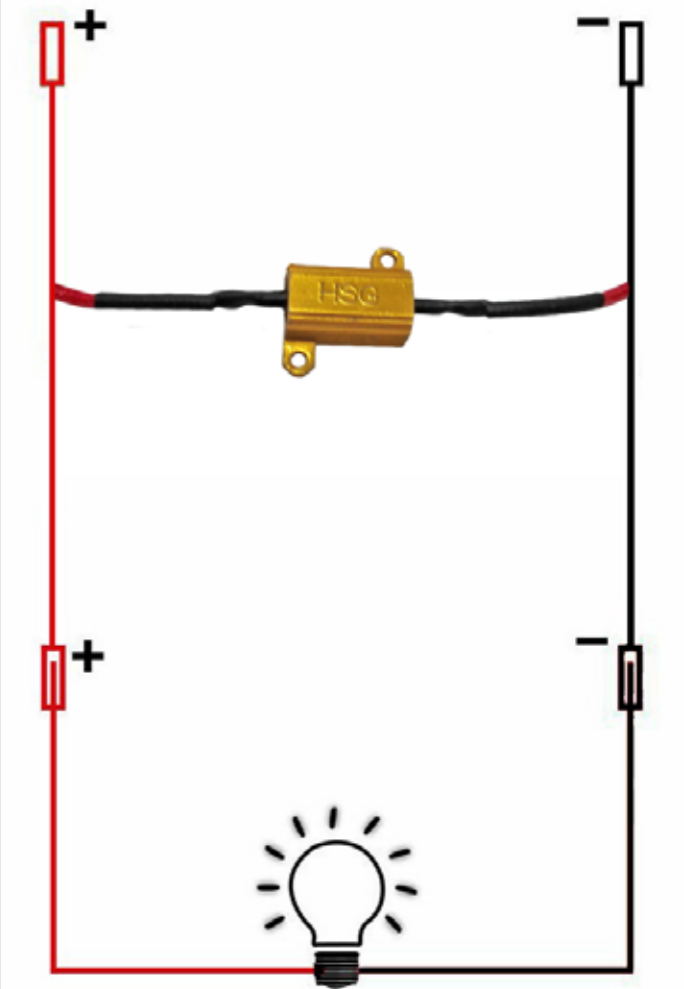

LAMPADA A LED

ART. 40603



5200LM

- LAMPADA A LED PER ANGEL EYES ULTRA BIANCA
- COMPATIBILITÀ:
 - SERIE 1: E82,E87 COUPE,HATCHBACK 2008 IN POI
 - SERIE 3: E90,E91,E92,E93 2008,9 IN POI

ART. 40553

ENTRY LEVEL



5200LM

- SERIE 5: E60,E61 (FACELIFT)2007,05 IN POI
- SERIE 6: E63 E64 2007,07 IN POI
- SERIE X: E70,E71 DAL 2007 IN POI
- SERIE Z: E89 Z4
- X1:E84
- ATTACCO: H8



ART. 40150



6000 LUMEN PER FARETTO

LUCE BIANCA FREDDA 6000K

IMPERMEABILE IP68

12 VOLT

- 3 TIPI DI LUCE:
- LUCE BIANCA FISSA
 - LUCE BIANCA FLASH
 - LUCE GIALLA ANTINEBBIA

ART. 41070



- LAMPADA A LED PER ANGEL EYES ULTRA BIANCA
- 10 WATT LED CREE
- COMPATIBILITÀ:
 - E87 1-SERIES (2004-2007 MODELS)
 - E39 5-SERIES (2001-2003 MODELS)
 - E60 E61 5-SERIES (2004-2007 MODELS - SOLO CON MODELLI HID XENON DI SERIE)
 - E63 E64 6-SERIES (2004-2007 MODELS)
 - E65 E66 7-SERIES (2002-2007 MODELS)
 - E53 X5-SERIES (2004-2006 MODELS)
 - X SERIES: E83 X3 2007 IN POI
- SPECIFICHE TECNICHE:
 - VOLTAGGIO: 12V;
 - POTENZA DI CONSUMO PER OGNI LAMPADA A LED: 10W;
 - COLORAZIONE: 5500K-6500K (BIANCO GHIACCIO)



ART. 41071



- LAMPADA A LED PER ANGEL EYES ULTRA BIANCA
- 40 WATT LED CREE
- COMPATIBILITÀ:
 - BMW E90 E91 (FINO AL 2008)
 - BMW X5 (DAL 2010 IN POI)
- SPECIFICHE TECNICHE:
 - VOLTAGGIO: 12V;
 - POTENZA DI CONSUMO PER OGNI LAMPADA LED: 40W;
 - COLORAZIONE: 5500K-6500K
 - COLORAZIONE: BIANCO GHIACCIO



ART. 40151



12 VOLT

6000 LUMEN PER FARETTO

LUCE BIANCA FREDDA 6000K

IMPERMEABILE IP68

ART. 40050



KIT LUCI TARGA PERSONALIZZATO GOLF IV,V, SEAT IBIZA

- VW GOLF4 1997-2005
- GOLF5 2003-2008
- Lupo 1998-2005
- Polo 9N 2001-2009
- Passat 3c B6 Limousine 2005-2010
- SEAT Ibiza 2012



ART. 40051



KIT LUCI TARGA PERSONALIZZATO AUDI Q5 A4 A5 A6 A7 TT RS TTRS, VW GOLF V VI

- AUDI Q5 '08-'10 A4 4D/5D '08-'10 S5 '08-'10 A5 '07-'10 TT '07-'A6 2011-'A7 2011-'TT/TTTS 2011-'RS5 2012-'TTRS 2011-
- VW GOLF 6 PLUS 2009- GOLF 6 VARIANT 5D 2009- JETTA Mk6 2011-
- VW PASSAT 5D '08-'09/PASSAT 5D R36 '08-'09 POLO 4D SEDAN 2010- /PASSAT
- B6 (4D or 5D) 2009- /PASSAT B7 5D WAGON 2011- /
- VW SHARAN 2011- TOURAN 2011- TOUAREG 2011-



ART. 40052



KIT LUCI TARGA PERSONALIZZATO AUDI A1 A6 , VW GOLF VI , SEAT IBIZA

- AUDI A1 2011- A6 2011- A6Q 2011- A7 2011-TT/TTTS 2011- RS5 2012- TTRS 2011-
- VW GOLF 6 PLUS 2009- GOLF 6 VARIANT 5D 2009-
- VW JETTA Mk6 2011- PASSAT B6 (4D OR 5D) 2009-
- VW PASSAT B7 5D WAGON 2011-
- VW POLO 4D Sedan 2010- SHARAN 2011-
- VW TOURAN 2011- TOUAREG 2011-



ART. 40062



KIT LUCI TARGA PERSONALIZZATO MERCEDES , SMART

- Mercedes Benz Smart Viano Vito
- Smart
- Voltaggio: 12V;
- Potenza di consumo per ogni lampada a led: 3W;
- Colorazione: 6000K (Bianco Ghiaccio)



ART. 40063



KIT LUCI TARGA PERSONALIZZATO FORD , JAGUAR

- Ford Focus 5d Dopo 2009
- Ford Mondeo Dopo 2008
- Ford Fiesta Dopo 2009
- Jaguar XF 2009
- Voltaggio: 12V;



ART. 40064



KIT LUCI TARGA PERSONALIZZATO FORD

- Ford Focus C-MAX Dopo 2003
- Ford Focus MK2 2003-2008
- Compatibile con codice articoli FORD: 4 502 331 e 4 502 332
- Voltaggio: 12V;
- Potenza di consumo per ogni lampada a led: 5W



ART. 40053



KIT LUCI TARGA PERSONALIZZATO AUDI A1 S LINE, VW PASSAT, PORSCHE PANAMERA

- AUDI A1 S Line Dopo 2011
- AUDI Q5 (2008-2010) A4 4D/5D (2008-2010)
- AUDI S5 (2008-2010) A5 (2007-2010) TT (2007-2010)
- VW Passat 5D (2008-2010)
- VW Passat 5D R36 (2008-2010)
- Porsche Panamera 4D (Dopo 2010)



ART. 40054



KIT LUCI TARGA PERSONALIZZATO VW, PORSCHE

- Porsche Cayenne 2002-2010 (*OEM part no. 95563162002; Chassis model 9PA / 9PA1)
- VW Touareg 2003-2010 (*with space-saving spare wheel)
- VW Tiguan
- VW Golf 5 5D touring
- VW Passat (B5.5) 5D touring



ART. 40055



KIT LUCI TARGA PERSONALIZZATO FIAT 500X

- Fiat 500X
- Ford Falcon
- Voltaggio: 12V;
- Potenza di consumo per ogni lampada a led: 5W;
- Colorazione: 6000K (Bianco Ghiaccio)



ART. 40065



KIT LUCI TARGA PERSONALIZZATO OPEL,CHEVROLET

- Chevrolet Camaro Cruze
- Opel Insignia Mokka 2012
- Voltaggio: 12V;
- Potenza di consumo per ogni lampada a led: 3W;
- Luminosità 200 Lumen



ART. 40066



KIT LUCI TARGA PERSONALIZZATO OPEL

- Opel Astra J
- Opel Zafira-C
- Voltaggio: 12V;
- Potenza di consumo per ogni lampada a led: 3W;
- Luminosità 200 Lumen



ART. 40067



KIT LUCI TARGA PERSONALIZZATO SMART FORTWO

- Smart Fortwo
- Voltaggio: 12V;
- Potenza di consumo per ogni lampada a led: 5W;
- Colorazione: 6000K (Bianco Ghiaccio)



ART. 40056



KIT LUCI TARGA PERSONALIZZATO FIAT 500L, ALFA ROMEO MITO, GIULIETTA, OPEL, MINI

- Compatibile con luci targa Codice OEM Fiat 51762788-
- Opel Zafira B 05-11,
- Opel Astra H 04-09,
- Opel Corsa D 06-11,
- Opel Insignia Dopo 2008
- Fiat Grande Punto 1,3 Multijet 2005



ART. 40057



KIT LUCI TARGA PERSONALIZZATO FIAT 500

- Fiat 500 500C Con OEM Part Number 51800482
- Voltaggio: 12V;
- Potenza di consumo per ogni lampada a led: 3W;
- Colorazione: 6000K (Bianco Ghiaccio)
- LUMINOSITÀ 200 Lumen



ART. 40058



KIT LUCI TARGA PERSONALIZZATO BMW, ALFA ROMEO

- BMW E63, E63N, E64, E64N
- BMW E81, E87, E87N (Prima del 09-2007)
- BMW E85 (Z4 roadster), E86 (Z4 coupe)
- Mini R55



ART. 40068



KIT LUCI TARGA PERSONALIZZATO RENAULT

- RENAULT Twingo
- RENAULT Clio 3D 2006.09
- RENAULT Clio 5D 2006.09
- RENAULT Megane 3D 2006.02
- RENAULT Megane 5D 2006.02
- RENAULT Megane kombi



ART. 40069



KIT LUCI TARGA PERSONALIZZATO PEUGEOT CITROEN

- PEUGEOT:
- 106 Facelift 1997-2004
- 1007
- 207
- 307
- 308



ART. 40070



KIT LUCI TARGA PERSONALIZZATO MINI

- MINI COOPER R56
- Voltaggio: 12V;
- Potenza di consumo per ogni lampada a led: 5W;
- Colorazione: 6000K (Bianco Ghiaccio)



ART. 40059



KIT LUCI TARGA PERSONALIZZATO BMW CON PLAFONIERA LED DI SERIE

- BMW E87 LCI E63LCI E46 LCI E89 F20 F12 F13 Con Plafoniera Led Di Serie
- N.OEM 63267193294-
- Voltaggio: 12V;
- Potenza di consumo per ogni lampada a led: 5W;
- Colorazione: 6000K (Bianco Ghiaccio)



ART. 40060



KIT LUCI TARGA PERSONALIZZATO BMW

- BMW E82 E88 E70 E71 E90 E90N E91 E92 E93 M3 CSL E39 E46 E60 E60N E61
- E61N
- Voltaggio: 12V;
- Potenza di consumo per ogni lampada a led: 5W;
- Colorazione: 6000K (Bianco Ghiaccio)



ART. 40061



KIT LUCI TARGA PERSONALIZZATO MERCEDES

- Mercedes Benz ML350 W251 R300 S400 R500 ML400 GL450 GL500
- OEM Parts Number:A 251 820 00 66
- Voltaggio: 12V;
- Potenza di consumo per ogni lampada a led: 3W;
- Colorazione: 6000K (Bianco Ghiaccio)



ART. 40071



KIT LUCI TARGA PERSONALIZZATO AUDI

- Audi Q7 2007 2009;
- Audi S6 2005 2009;
- Audi A3 Cabriolet 2009;
- Audi RS4 Avant Quattro 2006 2008;
- Audi RS4 Cabriolet 2006 2008;
- Audi RS6 Plus Avant 2008 2009;



ART. 40072



KIT LUCI TARGA PERSONALIZZATO VW

- VW EOS 2006-2015 - Lupo 1998+2006
- VW Amarok 2008- - Bora 1998-2005
- VW Golf4 1997-2005 - Golf5 2003-2008
- VW Golf6 2008-2012 - Golf7 2012.10
- VW New beetle facelift 2006-2010
- VW passat 3C B6 B7 2005-2010
- VW passat CC 2008- - Phaeton 2002-2016
- VW polo (6N2) 1999-2001 - Polo(9N) 2001-2009
- VW polo (6R) 2009- - Scirocco3 2008



ART. 40073



KIT LUCI TARGA PERSONALIZZATO NISSAN/MERCEDES

- NISSAN Navara ab 2004
- NISSAN Juke (F15) ab 2011
- NISSAN Note 2006-2013
- NISSAN Pathfinder ab 2005
- NISSAN Primera (P12, WP12) 2002-2007
- NISSAN NV 200 Evalia ab 2013
- NISSAN Qashqai I (J10) 2007-2013
- NISSAN Qashqai II (J11) ab 2014
- NISSAN X-Trail (T31) 2009-2013
- MERCEDES-BENZ (Canbus) Sprinter W906 ab 2006
- MERCEDES-BENZ (Canbus) Vito / Viano W639 2003-2014



ART. 40752A



TRUCK

H7

24V

KIT A LED H7 24 VOLT SPECIFICO TRUCK (2 PCS.)

- LED POWER: 48W (SINGLE)
- COMPONENTE LED CHIP ZES DI ELEVATA EFFICIENZA E QUALITÀ, STUDIATO SPECIFICAMENTE PER KIT A LED TRUCK
- PRODOTTO IN ALLUMINIO 6063
- DOPPIO DISSIPATORE DEL CALORE CON VENTOLA
- DC 24 VOLT
- WATERPROOF: IP68
- 8000 LM (LUMEN)
- TEMPERATURA COLORE: 6000K
- LIFETIME: >30.000 ORE
- TEMPERATURA OPERATIVA: DA -45°C A +120°C
- ANGOLO FASCIO D'ILLUMINAZIONE REGOLABILE A 360°

ART. 40751



TRUCK

H4

24V

KIT A LED H4 24 VOLT SPECIFICO TRUCK (2 PCS.)

- LED POWER: 48W (HIGH/LOW)
- COMPONENTE LED CHIP ZES DI ELEVATA EFFICIENZA E QUALITÀ, STUDIATO SPECIFICAMENTE PER KIT A LED TRUCK
- PRODOTTO IN ALLUMINIO 6063
- DOPPIO DISSIPATORE DEL CALORE CON VENTOLA
- DC 24 VOLT
- WATERPROOF: IP68
- 8000 LM (LUMEN)
- TEMPERATURA COLORE: 6000K
- LIFETIME: >30.000 ORE
- TEMPERATURA OPERATIVA: DA -45°C A +120°C
- ANGOLO FASCIO D'ILLUMINAZIONE REGOLABILE A 360°

ART. 40756A



TRUCK

H1

24V

KIT A LED H1 24 VOLT SPECIFICO TRUCK (2 PCS.)

- LED POWER: 48W (SINGLE)
- COMPONENTE LED CHIP ZES DI ELEVATA EFFICIENZA E QUALITÀ, STUDIATO SPECIFICAMENTE PER KIT A LED TRUCK
- PRODOTTO IN ALLUMINIO 6063
- DOPPIO DISSIPATORE DEL CALORE CON VENTOLA
- DC 24 VOLT
- WATERPROOF: IP68
- 8000 LM (LUMEN)
- TEMPERATURA COLORE: 6000K
- LIFETIME: >30.000 ORE
- TEMPERATURA OPERATIVA: DA -45°C A +120°C
- ANGOLO FASCIO D'ILLUMINAZIONE REGOLABILE A 360°

ART. 43160



12/24 Volt

LUCE FREDDA 6000K

SINGOLO FILAMENTO

- INPUT (MA): 450±20
- 12/24 VOLT
- LUMENS (LM): 800
- LED QUANTITY: 13 SMD
- PCB: ALUMINUM SUBSTRATE
- BEAM ANGLE: 360°
- LAMPADA DI POSIZIONE A LED

- USAGE: BACK-UP LIGHT, TURNING LIGHT, TAIL LIGHT
- BA15S - 1156 - P21W
- SINGOLO FILAMENTO
- CAN BUS NO ERROR
- LUCE BIANCA FREDDA 6000K

ART. 43150



12/24 Volt

LUCE FREDDA 6000K

SINGOLO FILAMENTO

- INPUT (MA): 450±20
- 12/24 VOLT
- LUMENS (LM): 800
- LED QUANTITY: 13 SMD
- PCB: ALUMINUM SUBSTRATE
- BEAM ANGLE: 360°
- LAMPADA DI POSIZIONE A LED

- USAGE: BACK-UP LIGHT, TURNING LIGHT, TAIL LIGHT
- T20 - 7440 - W21W
- SINGOLO FILAMENTO
- CAN BUS NO ERROR
- LUCE BIANCA FREDDA 6000K

ART. 43161



12/24 Volt

LUCE FREDDA 6000K

DOPPIO FILAMENTO

- INPUT (MA): H 450±20 - L 100±20
- 12/24 VOLT
- LUMENS (LM): 800
- LED QUANTITY: 13 SMD
- PCB: ALUMINUM SUBSTRATE
- BEAM ANGLE: 360°
- LAMPADA DI POSIZIONE A LED

- USAGE: BACK-UP LIGHT, TURNING LIGHT, TAIL LIGHT
- BAY15D - 1157 - P21W/5W
- DOPPIO FILAMENTO
- CAN BUS NO ERROR
- LUCE BIANCA FREDDA 6000K

ART. 43151



12/24 Volt

LUCE FREDDA 6000K

DOPPIO FILAMENTO

- INPUT (MA): H 450±20 - L 100±20
- 12/24 VOLT
- LUMENS (LM): 800
- LED QUANTITY: 13 SMD
- PCB: ALUMINUM SUBSTRATE
- BEAM ANGLE: 360°
- LAMPADA DI POSIZIONE A LED

- USAGE: BACK-UP LIGHT, TURNING LIGHT, TAIL LIGHT
- T20/21-5W - 7443 - W21/5W
- DOPPIO FILAMENTO
- CAN BUS NO ERROR
- LUCE BIANCA FREDDA 6000K

ART. 43162



12/24 Volt

LUCE FRECCE COLOR ARANCIONE

SINGOLO FILAMENTO

- INPUT (MA): 450±20
- 12/24 VOLT
- LUMENS (LM): 800
- LED QUANTITY: 13 SMD
- PCB: ALUMINUM SUBSTRATE
- BEAM ANGLE: 360°
- LAMPADA FRECCE A LED

- USAGE: BACK-UP LIGHT, TURNING LIGHT, TAIL LIGHT
- PY21W - S25 - BAU15S
- SINGOLO FILAMENTO
- CAN BUS NO ERROR
- LUCE ARANCIONE FRECCE

ART. 43163



12/24 Volt

LUCE POSIZIONE/STOP COLOR ROSSO

DOPPIO FILAMENTO

- INPUT (MA): H 450±20 - L 100±20
- 12/24 VOLT
- LUMENS (LM): 800
- LED QUANTITY: 13 SMD
- PCB: ALUMINUM SUBSTRATE
- BEAM ANGLE: 360°
- LAMPADA POSIZIONE/STOP A LED

- USAGE: BACK-UP LIGHT, TURNING LIGHT, TAIL LIGHT
- BAY15D - 1157 - P21/5W
- SINGOLO FILAMENTO
- CAN BUS NO ERROR
- LUCE ROSSA POSIZIONE/STOP

ART. 43152



12/24 Volt

SINGOLO FILAMENTO

LUCE FRECCIE COLOR ARANCIONE

- INPUT (MA): 450±20
- 12/24 VOLT
- LUMENS (LM): 800
- LED QUANTITY: 13 SMD
- PCB: ALUMINUM SUBSTRATE
- BEAM ANGLE: 360°
- LAMPADA FRECCIE A LED

- USAGE: BACK-UP LIGHT, TURNING LIGHT, TAIL LIGHT
- T20 - 7440 - W21W
- SINGOLO FILAMENTO
- CAN BUS NO ERROR
- LUCE ARANCIONE FRECCIE

ART. 42001

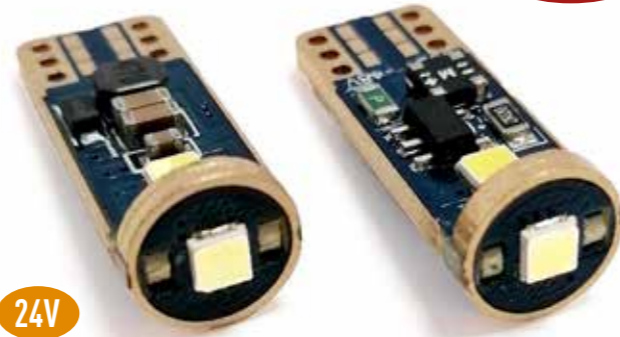

TRUCK

24V

CANBUS

- BASE: T10 W5W (TUTTO VETRO)
- 3 LED SMD "5050"
- LUCE BIANCA FREDDA
- 24 VOLT
- CANBUS

ART. 43230 - 31 mm

ART. 43231 - 36 mm



12/24 Volt

TRUCK

- SILURO T11 C5W
- 31 mm / 36 mm
- 6 LED SMD "5050"
- LUCE BIANCA FREDDA
- 12/24 VOLT

ART. 43232 - 39 mm

ART. 43233 - 42 mm



12/24 Volt

TRUCK

- SILURO T11 C5W
- 39 mm / 42 mm
- 6 LED SMD "5050"
- LUCE BIANCA FREDDA
- 12/24 VOLT

ART. 43101

24V



TRUCK

- BASE: T10 W5W (TUTTO VETRO)
- 5 LED SMD "3030"
- LUCE BIANCA FREDDA
- 24 VOLT

ART. 42003

24V



TRUCK

- BASE: T10 W5W (TUTTO VETRO)
- 8 LED SMD
- LUCE BIANCA FREDDA
- 24 VOLT

ART. 40586

H1



KIT FARI A LED PLUG AND PLAY (COMPOSTO DA 2 PEZZI)

- H1 / H3
- LED POWER: 30W (SINGLE)
- COMPONENTE LED CHIP DI ELEVATA EFFICIENZA E QUALITÀ, STUDIATO SPECIFICAMENTE PER KIT A LED
- PRODOTTO IN ALLUMINIO
- DOTATO DI DISSIPATORE DEL CALORE
- DC 12V-24V
- INPUT 1.2A±0.1A
- WATERPROOF: IP67
- 6000LM (LUMEN)
- TEMPERATURA COLORE: 6000K
- LIFETIME: >10.000 ORE
- TEMPERATURA OPERATIVA: DA -50°C A +90°C

STESSE DIMENSIONI DELLA LAMPADA ORIGINALE

ART. 40589

H3



ART. 42260

24V



TRUCK

BA15S - G18,5



- BASE: BA15S G18,5
- SINGOLO FILAMENTO
- 8 LED
- LUCE BIANCA FREDDA
- 24 VOLT

ART. 42266

24V

T4W



TRUCK

- BASE: BA9S T4W
- PIEDI DRITTI ALLINEATI
- 5 LED SMD "5050"
- LUCE BIANCA FREDDA
- 24 VOLT

ART. 42282

24V



TRUCK

- COPPIA RESISTENZE PER SIMULARE UN CARICO DA 21 WATT A 24 VOLT

ART. 42281

24V



TRUCK

- COPPIA RESISTENZE PER SIMULARE UN CARICO DA 5 WATT A 24 VOLT

ART. 40259 (24 VOLT)

24V

H7



TRUCK

FILTRO CANCELLER PER KIT A LED H7 24 VOLT

ART. 40116

7500 LUMEN



CON INTERRUTTORE



- 30 HIGH POWER LED AD ALTISSIMA LUMINOSITÀ
- ASSORBIMENTO: 48W -3,8A A 12V E 1,9A A 24V
- TENSIONE DI LAVORO: DA 10V A 30V DC
- WATERPROOF RATE: IP 68
- COLORE BIANCO FREDDO: 6000K
- MATERIALE DI COSTRUZIONE: INTERAMENTE IN ALLUMINIO
- COMPLETO DI STAFFE DI FISSAGGIO IN ALLUMINIO
- LUNGHISSIMA DURATA OLTRE 50.000 ORE

ART. 40102

2300 LUMEN

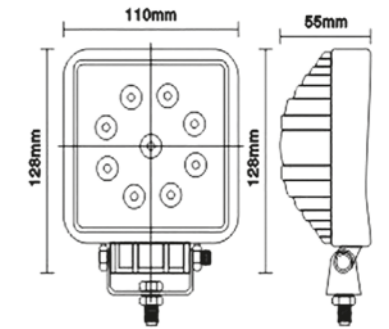

- 9 HIGH POWER LED AD ALTISSIMA LUMINOSITÀ
- ASSORBIMENTO: 27W -2,0A A 12V E 0,9A A 24V
- TENSIONE DI LAVORO: DA 10V A 30V DC
- WATERPROOF RATE: IP 68
- COLORE BIANCO FREDDO: 6000K
- MATERIALE DI COSTRUZIONE: INTERAMENTE IN ALLUMINIO
- COMPLETO DI STAFFE DI FISSAGGIO IN ALLUMINIO
- LUNGHISSIMA DURATA OLTRE 50.000 ORE

ART. 40106

4000 LUMEN

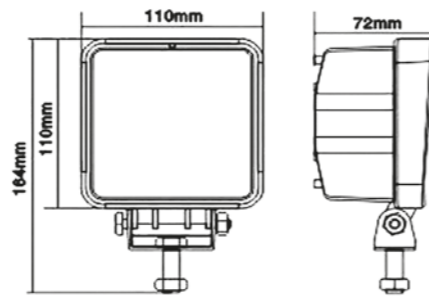

- 16 HIGH POWER LED AD ALTISSIMA LUMINOSITÀ
- ASSORBIMENTO: 48W -3,8A A 12V E 1,9A A 24V
- TENSIONE DI LAVORO: DA 10V A 30V DC
- WATERPROOF RATE: IP 68
- COLORE BIANCO FREDDO: 6000K
- MATERIALE DI COSTRUZIONE: INTERAMENTE IN ALLUMINIO
- COMPLETO DI STAFFE DI FISSAGGIO IN ALLUMINIO
- LUNGHISSIMA DURATA OLTRE 50.000 ORE

ART. 40105

1500 LUMEN

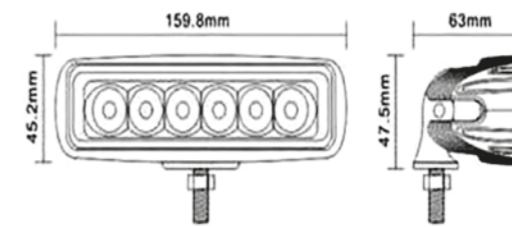

- 6 HIGH POWER LED AD ALTISSIMA LUMINOSITÀ
- ASSORBIMENTO: 18W -1,4A A 12V E 0,7A A 24V
- TENSIONE DI LAVORO: DA 10V A 30V DC
- WATERPROOF RATE: IP 68
- COLORE BIANCO FREDDO: 6000K
- MATERIALE DI COSTRUZIONE: INTERAMENTE IN ALLUMINIO
- COMPLETO DI STAFFE DI FISSAGGIO IN ALLUMINIO
- LUNGHISSIMA DURATA OLTRE 50.000 ORE

ART. 40101

2300 LUMEN

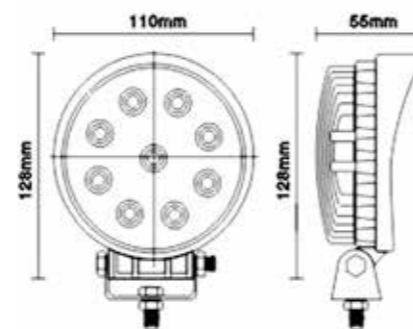

- 9 HIGH POWER LED AD ALTISSIMA LUMINOSITÀ
- ASSORBIMENTO: 27W -2,0A A 12V E 0,9A A 24V
- TENSIONE DI LAVORO: DA 10V A 30V DC
- WATERPROOF RATE: IP 68
- COLORE BIANCO FREDDO: 6000K
- MATERIALE DI COSTRUZIONE: INTERAMENTE IN ALLUMINIO
- COMPLETO DI STAFFE DI FISSAGGIO IN ALLUMINIO
- LUNGHISSIMA DURATA OLTRE 50.000 ORE

ART. 40108

1620 LUMEN

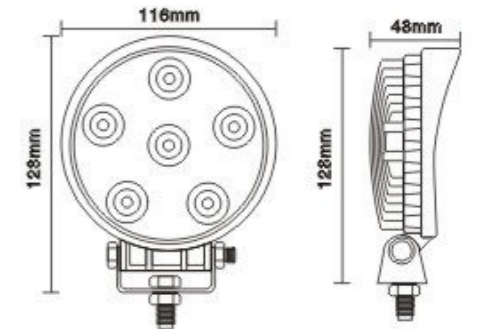

- 6 HIGH POWER LED AD ALTISSIMA LUMINOSITÀ
- ASSORBIMENTO: 1,46A A 12V -0,7A A 24V
- TENSIONE DI LAVORO: DA 10 A 30V DC
- WATERPROOF RATE : IP 67
- COLORE BIANCO FREDDO: 6000K
- MATERIALE DI COSTRUZIONE INTERAMENTE IN ALLUMINIO
- COMPLETO DI STAFFA DI MONTAGGIO IN ACCIAIO
- LUNGHISSIMA DURATA OLTRE 30.000 ORE

ART. 40109

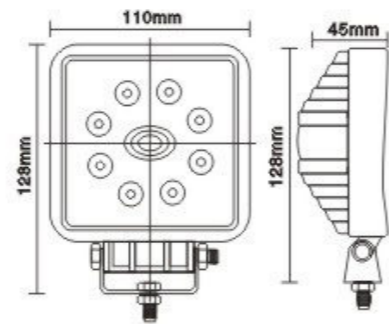

- 8 HIGH POWER LED AD ALTISSIMA LUMINOSITÀ
- ASSORBIMENTO: 1,8A A 12V--0,9A A 24V
- TENSIONE DI LAVORO: DA 10 A 30V DC
- WATERPROOF RATE: IP 67
- COLORE BIANCO FREDDO: 6000K
- MATERIALE DI COSTRUZIONE INTERAMENTE IN ALLUMINIO
- COMPLETO DI STAFFA DI MONTAGGIO IN ACCIAIO
- LUNGHISSIMA DURATA OLTRE 30.000 ORE

2160 LUMEN

ART. 40104

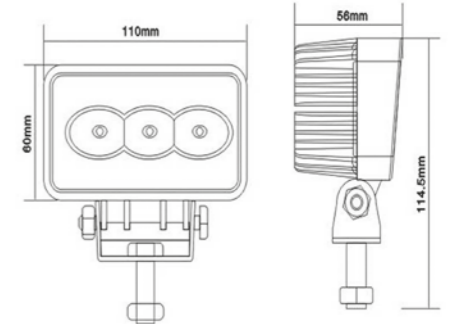

- 3 HIGH POWER LED AD ALTISSIMA LUMINOSITÀ
- ASSORBIMENTO: 9W -0,85A A 12V E 0,42A A 24V
- TENSIONE DI LAVORO: DA 10V A 30V DC
- WATERPROOF RATE: IP 68
- COLORE BIANCO FREDDO: 6000K
- MATERIALE DI COSTRUZIONE: INTERAMENTE IN ALLUMINIO
- COMPLETO DI STAFFE DI FISSAGGIO IN ALLUMINIO
- LUNGHISSIMA DURATA OLTRE 50.000 ORE

1000 LUMEN

ART. 40103

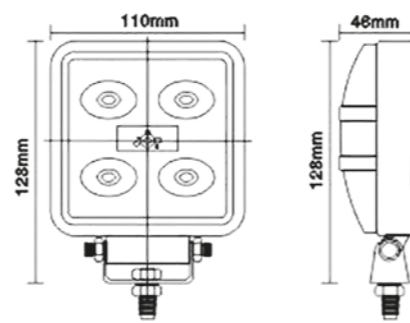

- 5 HIGH POWER LED AD ALTISSIMA LUMINOSITÀ
- ASSORBIMENTO: 15W -1,3A A 12V E 0,65A A 24V
- TENSIONE DI LAVORO: DA 10V A 30V DC
- WATERPROOF RATE: IP 68
- COLORE BIANCO FREDDO: 6000K
- MATERIALE DI COSTRUZIONE: INTERAMENTE IN ALLUMINIO
- COMPLETO DI STAFFE DI FISSAGGIO IN ALLUMINIO
- LUNGHISSIMA DURATA OLTRE 50.000 ORE

1350 LUMEN

ART. 40113



- POTENZA TOTALE DEI LED: 10W
- LUMINOSITÀ: 1500 LUMEN
- TENSIONE DI LAVORO: DA 10 A 30V DC
- WATERPROOF: IP 68
- 1 CREE LED DA 10 WATT
- ASSORBIMENTO: 1A A 12V--0,5A A 24V
- COLORE BIANCO FREDDO: 6000K
- MATERIALE DI COSTRUZIONE ALLUMINIO
- LENTE IN VETRO
- CORREDATO DI STAFFA DI MONTAGGIO IN ACCIAIO
- DURATA VITA FARETTO: 30.000 ORE
- OMOLOGATI: CE® ROHS® IP68

1500 LUMEN

ART. 40115



- 6 HIGH POWER LED AD ALTISSIMA LUMINOSITÀ
- ASSORBIMENTO: 1,8A A 12V--0,9A A 24V
- TENSIONE DI LAVORO: DA 10 A 30V DC
- WATERPROOF RATE: IP 68
- COLORE BIANCO FREDDO: 6000K
- MATERIALE DI COSTRUZIONE INTERAMENTE IN ALLUMINIO
- COMPLETO DI STAFFA DI MONTAGGIO IN ACCIAIO
- LUNGHISSIMA DURATA OLTRE 30.000 ORE

2000 LUMEN

ART. 40114



- 6 HIGH POWER LED AD ALTISSIMA LUMINOSITÀ
- ASSORBIMENTO: 1,8A A 12V--0,9A A 24V
- TENSIONE DI LAVORO: DA 10 A 30V DC
- WATERPROOF RATE: IP 68
- COLORE BIANCO FREDDO: 6000K
- MATERIALE DI COSTRUZIONE INTERAMENTE IN ALLUMINIO
- COMPLETO DI STAFFA DI MONTAGGIO IN ACCIAIO
- LUNGHISSIMA DURATA OLTRE 30.000 ORE

2400 LUMEN

ART. 40121

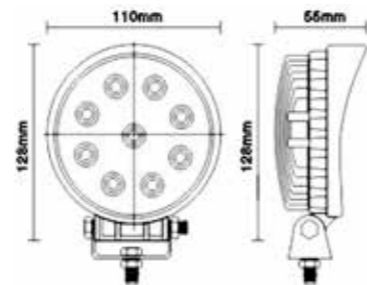

- POTENZA TOTALE DEI LED: 27W
- LUMINOSITÀ: 2300 LUMEN
- TENSIONE DI LAVORO: DA 10 A 30V DC
- WATERPROOF: IP 67
- 9 EPISTAR LED DA 3 WATT CADAUNO
- ASSORBIMENTO: 2A A 12V--0,9A A 24V
- COLORE BIANCO FREDDO: 6000K
- MATERIALE DI COSTRUZIONE ALLUMINIO
- LENTE IN PMMA
- CORREDATO DI STAFFA DI MONTAGGIO IN ACCIAIO
- FARO DI PROFONDITÀ: (30 GRADI)
- DURATA VITA FARETTO: 30.000 ORE

2300
LUMEN

ART. 40127

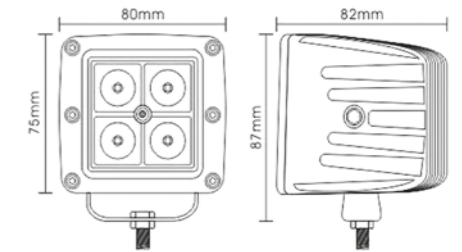

- POTENZA TOTALE DEI LED: 16W
- LUMINOSITÀ: 2100 LUMEN
- TENSIONE DI LAVORO: DA 10 A 30V DC
- WATERPROOF: IP 67
- 4 CREE LED DA 4 WATT CADAUNO
- ASSORBIMENTO: 1.34A A 12V--0.67A A 24V
- COLORE BIANCO FREDDO: 6000K
- MATERIALE DI COSTRUZIONE ALLUMINIO
- LENTE IN PVC
- CORREDATO DI STAFFA DI MONTAGGIO IN ACCIAIO
- FARO DI PROFONDITÀ: (8 GRADI)
- DURATA VITA FARETTO: 30.000 ORE

2100
LUMEN

ART. 40122

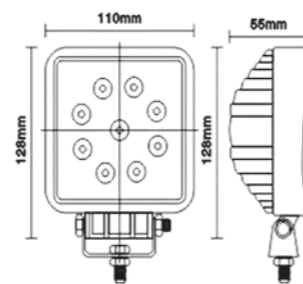

- POTENZA TOTALE DEI LED: 27W
- LUMINOSITÀ: 2300 LUMEN
- TENSIONE DI LAVORO: DA 10 A 30V DC
- WATERPROOF: IP 67
- 9 EPISTAR LED DA 3 WATT CADAUNO
- ASSORBIMENTO: 2A A 12V--0,9A A 24V
- COLORE BIANCO FREDDO: 6000K
- MATERIALE DI COSTRUZIONE ALLUMINIO
- LENTE IN PMMA
- CORREDATO DI STAFFA DI MONTAGGIO IN ACCIAIO
- FARO DI PROFONDITÀ: (30 GRADI)
- DURATA VITA FARETTO: 30.000 ORE

2300
LUMEN

ART. 40120



- POTENZA TOTALE DEI LED: 10W
- LUMINOSITÀ: 1500 LUMEN
- TENSIONE DI LAVORO: DA 10 A 30V DC
- WATERPROOF: IP 67
- 1 CREE LED DA 10 WATT
- ASSORBIMENTO: 1A A 12V--0,5A A 24V
- COLORE BIANCO FREDDO: 6000K
- MATERIALE DI COSTRUZIONE ALLUMINIO
- LENTE IN PVC
- CORREDATO DI STAFFA DI MONTAGGIO IN ACCIAIO
- FARO DI PROFONDITÀ: (8 GRADI)
- DURATA VITA FARETTO: 30.000 ORE

1500
LUMEN

ART. 40125

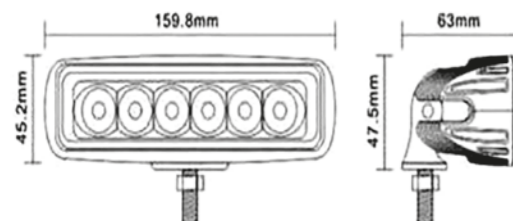

- POTENZA TOTALE DEI LED: 18W
- LUMINOSITÀ: 1500 LUMEN
- TENSIONE DI LAVORO: DA 10 A 30V DC
- WATERPROOF: IP 67
- 6 EPISTAR LED DA 3 WATT CADAUNO
- ASSORBIMENTO: 1.4A A 12V--0,7A A 24V
- COLORE BIANCO FREDDO: 6000K
- MATERIALE DI COSTRUZIONE ALLUMINIO
- LENTE IN PVC
- CORREDATO DI STAFFA DI MONTAGGIO IN ACCIAIO
- FARO DI PROFONDITÀ: (25 GRADI)
- DURATA VITA FARETTO: 30.000 ORE

1500
LUMEN

ART. 40123



- POTENZA TOTALE DEI LED: 10W
- LUMINOSITÀ: 1500 LUMEN
- TENSIONE DI LAVORO: DA 10 A 30V DC
- WATERPROOF: IP 68
- 1 CREE LED DA 10 WATT
- ASSORBIMENTO: 1A A 12V--0,5A A 24V
- COLORE BIANCO FREDDO: 6000K
- MATERIALE DI COSTRUZIONE ALLUMINIO
- LENTE IN VETRO
- CORREDATO DI STAFFA DI MONTAGGIO IN ACCIAIO
- FARO DI PROFONDITÀ: 8 GRADI
- DURATA VITA FARETTO: 30.000 ORE
- OMOLOGATI: CE® ROHS® IP68

1500
LUMEN

ART. 40950

**12
LED**



- POTENZA TOTALE DEI LED: 36W
- MISURE: 20 x 8 x 9 cm (lung. x larg. x prof.)
- LUMINOSITÀ: 2800 LUMEN
- TENSIONE DI LAVORO: DA 10 A 30V DC
- 6000K
- PESO: 1 KG
- WATERPROOF : IP 67
- MATERIALE DI COSTRUZIONE ALLUMINIO
- CORREDATO DI STAFFA DI MONTAGGIO IN ACCIAIO

ART. 40951

**24
LED**



- POTENZA TOTALE DEI LED: 72W
- MISURE: 36 x 8 x 9 cm (lung. x larg. x prof.)
- LUMINOSITÀ: 5600 LUMEN
- TENSIONE DI LAVORO: DA 10 A 30V DC
- 6000K
- PESO: 3 KG
- WATERPROOF : IP 67
- MATERIALE DI COSTRUZIONE ALLUMINIO
- CORREDATO DI STAFFA DI MONTAGGIO IN ACCIAIO

ART. 40952

**40
LED**



- POTENZA TOTALE DEI LED: 120W
- MISURE: 56 x 8 x 9 cm (lung. x larg. x prof.)
- LUMINOSITÀ: 9200 LUMEN
- TENSIONE DI LAVORO: DA 10 A 30V DC
- 6000K
- PESO: 4 KG
- WATERPROOF : IP 67
- MATERIALE DI COSTRUZIONE ALLUMINIO
- CORREDATO DI STAFFA DI MONTAGGIO IN ACCIAIO

ART. 40955

**108
LED**



- POTENZA TOTALE DEI LED: 300W
- MISURE: 132 x 8 x 9 cm (lung. x larg. x prof.)
- LUMINOSITÀ: 25000 LUMEN
- TENSIONE DI LAVORO: DA 10 A 30V DC
- 6000K
- PESO: 8 KG
- WATERPROOF : IP 67
- MATERIALE DI COSTRUZIONE ALLUMINIO
- CORREDATO DI STAFFA DI MONTAGGIO IN ACCIAIO

ART. 40953

**60
LED**



- POTENZA TOTALE DEI LED: 180W
- MISURE: 81 x 8 x 9 cm (lung. x larg. x prof.)
- LUMINOSITÀ: 14000 LUMEN
- TENSIONE DI LAVORO: DA 10 A 30V DC
- 6000K
- PESO: 5,3 KG
- WATERPROOF : IP 67
- MATERIALE DI COSTRUZIONE ALLUMINIO
- CORREDATO DI STAFFA DI MONTAGGIO IN ACCIAIO

ART. 40954

**80
LED**



- POTENZA TOTALE DEI LED: 240W
- MISURE: 107 x 8 x 9 cm (lung. x larg. x prof.)
- LUMINOSITÀ: 18000 LUMEN
- TENSIONE DI LAVORO: DA 10 A 30V DC
- 6000K
- PESO: 6,5 KG
- WATERPROOF : IP 67
- MATERIALE DI COSTRUZIONE ALLUMINIO
- CORREDATO DI STAFFA DI MONTAGGIO IN ACCIAIO

UTILIZZO SU CAMPER, ROULOTTE, FURGONI,
AUTO, ALLESTIMENTI VARI

BIANCO FREDDO
6000K

WATERPROOF IP64

ART. 40000 - 12V
ART. 40020 - 24V **30 cm**

- LUNGHEZZA 30 CM
- ALTEZZA 3,3 CM
- SPESSORE MAX 0,9 CM
- 42 LED
- 12 o 24 V - 4 W

ART. 40001 - 12V
ART. 40021 - 24V **50 cm**

- LUNGHEZZA 50 CM
- ALTEZZA 3,3 CM
- SPESSORE MAX 0,9 CM
- 56 LED
- 12 o 24 V - 6 W

ART. 40002 - 12V
ART. 40022 - 24V **100 cm**

- LUNGHEZZA 100 CM
- ALTEZZA 3,3 CM
- SPESSORE MAX 0,9 CM
- 112 LED
- 12 o 24 V - 12 W

IN DOTAZIONE
CON OGNI BARRA



COMPONIBILI TRA LORO GIUNZIONE PER PLAFONIERE

ART. 40007



ORIENTABILI 90°

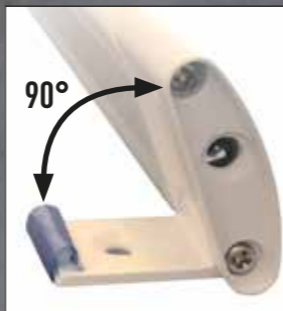

ACCESSORI

ART. 40005



- CONNETTORE (MORSETTIERA) ALIMENTAZIONE PLAFONIERE

ART. 40009



- INTERRUTTORE PER PLAFONIERE

ART. 40006



- INTERRUTTORE TOUCH PER PLAFONIERE

ART. 40008



- SENSORE DI PRESENZA PIR PER PLAFONIERE
- ORIENTABILE 90°
- TEMPO-REGOLABILE



INTERRUTTORE INCORPORATO

CORPO ALLUMINIO / LENTI POLICARBONATO

BIANCO FREDDO
6000K

ART. 40010 **26 cm**

- LUNGHEZZA 266 MM
- LARGHEZZA 28 MM
- SPESSORE 13,5 MM
- 18 LED
- 12/24 V

ART. 40011 **57 cm**

- LUNGHEZZA 570 MM
- LARGHEZZA 28 MM
- SPESSORE 13,5 MM
- 45 LED
- 12/24 V

ART. 40012 **97 cm**

- LUNGHEZZA 970 MM
- LARGHEZZA 28 MM
- SPESSORE 13,5 MM
- 81 LED
- 12/24 V

ALIMENTATORI DA 220 VOLT A 12 VOLT UTILIZZO: ILLUMINAZIONE A LED

ART. 70102 POWER 25,2 WATT / 2,1A

ART. 70104 POWER 75 WATT / 6A

ART. 70106 POWER 150 WATT / 12,5A



- INPUT 220 VOLT
- OUTPUT 12 VOLT
- WORKING TEMPERATURE: -20°C - +70°C
- HIGH EFFICIENCY, LONG LIFE AND HIGH RELIABILITY
- WITHSTAND 5G VIBRATION TEST
- LED INDICATOR FOR POWER ON
- 100% FULL LOAD BURN-IN TEST
- UNIVERSAL AC INPUT / FULL RANGE

ART. 40130

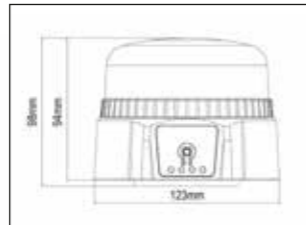

- 12/24 VOLT
- FISSAGGIO MAGNETICO
- RICARICABILE
- SPINOTTO ACCENDISIGARI IN DOTAZIONE
- OMOLOGATO R65-R10
- ALTEZZA 98 MM
- DIAMETRO 123 MM

12/24 V
FISSAGGIO MAGNETICO

ART. 40132



- 12/110 VOLT
- 5 TIPI DI LAMPEGGIO
- FISSAGGIO BASE PALO
- OMOLOGATO R165, ECE R10
- ALTEZZA 154 MM
- DIAMETRO 101 MM

12/110V
FISSAGGIO BASE PALO

ART. 40131



- 12/110 VOLT
- AVVISATORE ACUSTICO RETROMARCIA INTEGRATO
- BUZZER INTEGRATO
- 5 TIPI DI LAMPEGGIO
- OMOLOGATO ECE R65, ECE R10
- ALTEZZA 89 MM
- DIAMETRO 130 MM

12/110V
FISSAGGIO A VITI

ROLL.5050WW (sfondo bianco - luce bianca) - ROLL.5050WB (sfondo bianco - luce blu)



- 300 LED 5050 • 3 CHIP SU 5 METRI • SFONDO BIANCO • ALTISSIMA LUMINOSITA' • BOBINA A LED LUNGA 5 METRI • UTILIZZO: DECORO AUTO, ILLUMINAZIONI AUTO, CASA, CAMPER, TUNING
- IMPERMEABILE IP 67 • ILLUMINAZIONE: BIANCO GHIACCIO 6000K (COME GLI XENON) • TAGLIABILE OGNI 3 LED • COMPLETE DI BIADESIVO RESISTENTE ALL'ACQUA • LUNGA DURATA
- BASSISSIMO CONSUMO • 12 VOLT

ROLL.5050BR (sfondo nero - luce rossa) - ROLL.5050BB (sfondo nero - luce blu) - ROLL.5050BW (sfondo nero - luce bianca fredda)



- 300 LED 5050 • 3 CHIP SU 5 METRI • SFONDO NERO • ALTISSIMA LUMINOSITA' • BOBINA A LED LUNGA 5 METRI • UTILIZZO: DECORO AUTO, ILLUMINAZIONI AUTO, CASA, CAMPER, TUNING
- IMPERMEABILE IP 67 • ILLUMINAZIONE: BIANCO GHIACCIO 6000K (COME GLI XENON), NERO, ROSSO • TAGLIABILE OGNI 3 LED • COMPLETE DI BIADESIVO RESISTENTE ALL'ACQUA • LUNGA DURATA
- BASSISSIMO CONSUMO • 12 VOLT

ROLL.RGB (300 LED)



- 300 LED RGB SU 5 METRI • SFONDO TRASPARENTE • BOBINA A LED LUNGA 5 METRI • UTILIZZO: DECORO AUTO, ILLUMINAZIONI AUTO, CASA, CAMPER, TUNING
- IMPERMEABILE IP 67 • ILLUMINAZIONE: FULL RGB • TAGLIABILE OGNI 3 LED • COMPLETE DI BIADESIVO RESISTENTE ALL'ACQUA • LUNGA DURATA
- BASSISSIMO CONSUMO • 12 VOLT

ROLL.24V W (luce bianca fredda) - ROLL.24V B (luce blu) - ROLL.24V R (luce rossa) - ROLL.24V RGB



- 300 LED "3528" SU 5 METRI • BOBINA DA 5 METRI • SFONDO NERO • BOBINA A LED LUNGA 5 METRI • UTILIZZO: DECORO CAMION, CAMION TUNING
- IMPERMEABILE IP 67 • ILLUMINAZIONE: BIANCO GHIACCIO 6000K (COME GLI XENON), NERO, ROSSO, VERDE, ARANCIO • TAGLIABILE OGNI 3 LED • COMPLETE DI BIADESIVO RESISTENTE ALL'ACQUA • LUNGA DURATA
- BASSISSIMO CONSUMO • 24 VOLT

TC.RGB

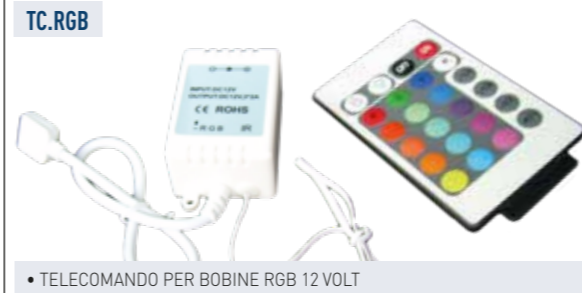

- TELECOMANDO PER BOBINE RGB 12 VOLT

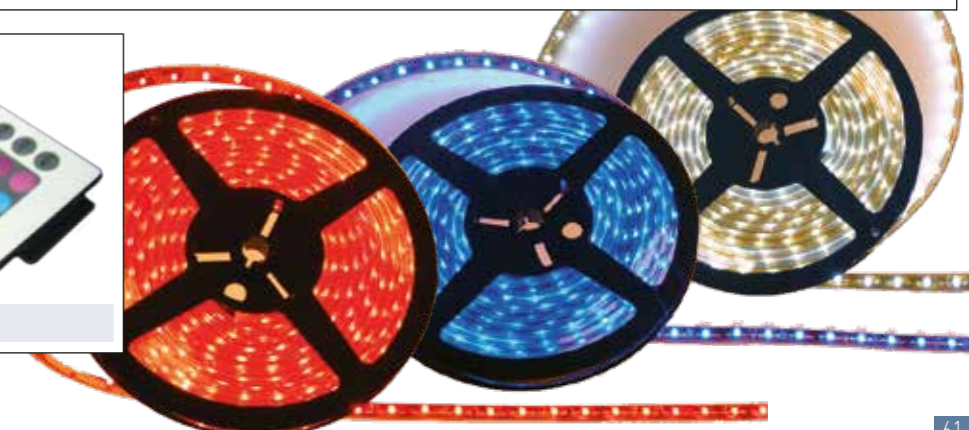

CAN BUS

RISOLVE TUTTE LE PROBLEMATICHE ANCHE SU AUTO PARTICOLARMENTE DIFFICILTOSI:
AUDI, MERCEDES, GRUPPO VW, BMW E TUTTE LE AUTO DI NUOVA GENERAZIONE.
CON IL KIT PRO LE CENTRALINE ELETTRONICHE DI TUTTE LE AUTO
NON SUBISCONO ALCUN DANNO. QUALITA' ESTREMA E DURATA NEL TEMPO.

12 VOLT CAN BUS

- ART. 45216 KIT XENON PROFESSIONALE CAN BUS H1 6000K 12 VOLT
- ART. 45213 KIT XENON PROFESSIONALE CAN BUS H11 6000K 12 VOLT
- ART. 45221 KIT XENON PROFESSIONALE CAN BUS H27 6000K 12 VOLT
- ART. 45211 KIT BIXENON PROFESSIONALE CAN BUS H4 6000K 12 VOLT
- ART. 45212 KIT XENON CAN BUS PROFESSIONALE H7 6000K 12 VOLT
- ART. 45232 KIT XENON PROFESSIONALE CAN BUS H7 5000K 12 VOLT
- ART. 45233 KIT XENON PROFESSIONALE CAN BUS H7 8000K 12 VOLT
- ART. 45234 KIT XENON CAN BUS PROFESSIONALE H7 CORTA 6000K 12 VOLT METAL BASE, CONSIGLIATO PER AUTO CON FARI PARABOLA OTTURATORE, PER EVITARE CHE LA LAMPADINA TOCCHI. QUESTO KIT E' INSISPENSABILE SU AUDI A3 (PER EVITARE DANNI)
- ART. 45235 KIT XENON PROFESSIONALE CAN BUS H7R SCHERMATA 6000K 12 VOLT
- ART. 45236 KIT XENON CAN BUS PROFESSIONALE H9 6000K 12 VOLT
- ART. 45217 KIT XENON PROFESSIONALE CAN BUS HB4 6000K 12 VOLT
- ART. 45238 KIT BIXENON CAN BUS PROFESSIONALE HB5 6000K 12 VOLT
- SET.PROMOTOH4BX KIT BIXENON MOTO PROFESSIONALE H4 6000K 12 VOLT CAN BUS
- ART. 45253 KIT XENON MOTO CAN BUS PROFESSIONALE H7 6000K 12 VOLT
- SET.PROTMAX KIT XENON SPECIFICO PER MOTO TMAX H7 METAL BASE E H4 BIXENON 6000K, 12 VOLT (2 ballast PRO, 1 lamp. H4BX, 1 lamp H7M) + ADATTATORE

TUTTI I KIT SONO
COMPOSTI
DA 2 BALLAST
E 2 LAMPADINE
AD ESCLUSIONE DEI KIT MOTO



XENON LINE

QUALITA' E CONVENIENZA. EXTRA SLIM PER MINOR INGOMBRO.

TUTTI I KIT SONO COMPOSTI DA 2 BALLAST E 2 LAMPADINE

AD ESCLUSIONE DEI KIT MOTO

12 VOLT STANDARD LINE

- ART. 45117 KIT XENON HB4 6000K 12 VOLT
- ART. 45114 KIT XENON HB3 6000K 12 VOLT
- ART. 45136 KIT XENON H9 6000K 12 VOLT
- ART. 45135 KIT XENON H7 SCHERMATA 6000K 12 VOLT
- ART. 45134 KIT XENON H7 6000K CORTA 12 VOLT
- ART. 45133 KIT XENON H7 8000K 12 VOLT
- ART. 45132 KIT XENON H7 5000 K 12 VOLT
- ART. 45112 KIT XENON H7 12 VOLT 6000K
- ART. 45111 KIT BIXENON H4 6000K 12 VOLT
- ART. 45119 KIT XENON H3 6000K 12 VOLT
- ART. 45123 KIT BIXENON H13 6000K 12 VOLT
- ART. 45113 KIT XENON H11 6000K 12 VOLT
- ART. 45116 KIT XENON H1 6000K 12 VOLT
- ART. 45122 KIT XENON D2S 6000K 12 VOLT

24 VOLT STANDARD LINE

- ART. 45152 KIT XENON H7 6000K 24 VOLT
- ART. 45151 KIT BIXENON H4 6000K 24 VOLT
- ART. 45153 KIT XENON H11 6000K 24 VOLT
- ART. 45156 KIT XENON H1 6000K 24 VOLT





ART. 45633

- LAMPADA HID XENON H7 6000K BASE IN METALLO



ART. 45636

- LAMPADA HID XENON H7 6000K BASE IN METALLO 50 WATT



ART. 45635

- LAMPADA HID XENON H7 5000K BASE IN METALLO

ART. 45634

- LAMPADA HID XENON H7 4300K BASE IN METALLO



ART. 45637

- LAMPADA HID XENON H7 8000K BASE IN METALLO



ART. 45640

- LAMPADA HID XENON H7R 6000K BASE IN METALLO

ART. 45641

- LAMPADA HID XENON H7R 5000K BASE IN METALLO



ART. 45638

- LAMPADA HID XENON H7 EXTRA CORTA 6000K BASE IN METALLO

ART. 45639

- LAMPADA HID XENON H7 EXTRA CORTA 5000K BASE IN METALLO



ART. 45612

- LAMPADA HID XENON H1 6000K

ART. 45621

- LAMPADA HID XENON H1 8000K

ART. 45619

- LAMPADA HID XENON H1 5000K



ART. 45643

- LAMPADA HID XENON H9 6000K



ART. 45614

- LAMPADA HID XENON H11 6000K

ART. 45615

- LAMPADA HID XENON H11 5000K

ART. 45613

- LAMPADA HID XENON H10 6000K

ART. 45622

- LAMPADA HID XENON H27 - 880 - 881 - 6000K



ART. 45628

- LAMPADA HID H4 BIXENON 6000K (BASE RIMOVIBILE)

ART. 45630

- LAMPADA HID H4 BIXENON 5000K (BASE RIMOVIBILE)

ART. 45629

- LAMPADA HID H4 BIXENON 4300K (BASE RIMOVIBILE)

ART. 45631

- LAMPADA HID H4 BIXENON 8000K (BASE RIMOVIBILE)



ART. 45627

- LAMPADA HID XENON H4 6000K (anabbagliante xenon, abbagliante alogeno)



ART. 45632

- LAMPADA HID H4 SINGOLA 6000K



ART. 45644

- LAMPADA HID XENON HB3 9005 6000K



ART. 45645

- LAMPADA HID XENON HB3 9005 5000K



ART. 45618

- LAMPADA HID H13 BIXENON 6000K



ART. 45646

- LAMPADA HID XENON HB4 9006 6000K



ART. 45647

- LAMPADA HID HB5 9007 6000K

ART. 45648

- LAMPADA HID HB5 9007 BIXENON 6000K



ART. 45642

- LAMPADA HID XENON HB8 6000K



ART. 45623

- LAMPADA HID XENON H3 6000K

ART. 45624

- LAMPADA HID XENON H3 5000K

ART. 45625

- LAMPADA HID XENON H3 8000K



ART. 45611S (1 PEZZO)

- LAMPADA HID XENON D4S - D4C 6000K



ART. 45609S (1 PEZZO)

- LAMPADA HID XENON D3S 6000K

ART. 45610S (1 PEZZO)

- LAMPADA HID XENON D3S 6000K

ART. 45608

- LAMPADA HID XENON D3C 6000K



ART. 45602S (1 PEZZO)

- LAMPADA HID XENON D1S 6000K

ART. 45603S (1 PEZZO)

- LAMPADA HID XENON D1S 4300K



ART. 45601S (1 PEZZO)

- LAMPADA HID XENON D1R 6000K



ART. 45606S (1 PEZZO)

- LAMPADA HID XENON D2R 6000K



ART. 45604S (1 PEZZO)

- LAMPADA HID XENON D2C 6000K

ART. 45605

- LAMPADA HID XENON D2H 6000K



ART. 45607S (1 PEZZO)

- LAMPADA HID XENON D2S 6000K



ART. 47761

- CONDENSATORI/STABILIZZATORI DI CORRENTE A 12 VOLT
- PER RISOLVERE I PROBLEMI NEGLI XENON DI SPIA ACCESA, SFARFALLO DELLE LUCI, SPEGNIMENTO DI UN FARO, ECC.
- 12 VOLT - 1 COPPIA

ART. 47762

- CONDENSATORI/STABILIZZATORI DI CORRENTE A 24 VOLT
- PER RISOLVERE I PROBLEMI NEGLI XENON DI SPIA ACCESA, SFARFALLO DELLE LUCI, SPEGNIMENTO DI UN FARO, ECC.
- 24 VOLT - 1 COPPIA



ART. 47756

- CABLAGGIO INDIPENDENTE PER SINGOLA LAMPADA H4-3 BIXENON.
- RICONOSCE AUTOMATICAMENTE LA POLARITA', INDISPENSABILE PER LE AUTO JAPPONESI CON POLARITA' INVERTITA'. CONSIGLIATO PER TUTTE LE AUTO CON H4 BIXENON PER SEMPLIFICARE
- L'INSTALLAZIONE. GIA' IN DOTAZIONE SUL SET. PRO H4.
- 12 VOLT - 1 COPPIA



ART. 47755

- CABLAGGIO INDIPENDENTE PER SINGOLA LAMPADA H4-3 BIXENON.
- CONSIGLIATO PER TUTTE LE AUTO CON H4 BIXENON PER SEMPLIFICARE
- L'INSTALLAZIONE. GIA' IN DOTAZIONE SUL NOSTRO SET.H4 STANDARD
- 12VOLT - 1 COPPIA



ART. 47760

- RESISTENZA CORRAZZATA PER KIT XENON, PORTA L'ASSORBIMENTO
- DEGLI XENON DA 35W A 55W PER ILLUDERE IL COMPUTER DI BORDO
- 12 VOLT - 1 COPPIA



ART. 45753

- CENTRALINA TRADIZIONALE CON CABLAGGIO PER XENON H4 BIXENON 12 VOLT

ART. 45754

- CENTRALINA TRADIZIONALE CON CABLAGGIO PER XENON H4 BIXENON 24 VOLT



ART. 45750

- PORTALAMPADA XENON PER D2S - D2R -2DC



ART. 45730

- CONVERTITORE ATTACCHI LAMPADA XENON AMP-KET



ART. 45727

- PORTALAMPADA XENON ORIGINALE D1S - D2S - D3S - D4S
- 1 COPPIA



ART. 45711

- PROLUNGA PER LAMPADA XENON DA 1 METRO



AD.128

- PORTALAMPADA XENON - MODIFICA
- CONVERTE DA D2S A H7.H1 O ALTRI MODELLI DI LAMPAD
- 1 COPPIA



AD.132

- Cablaggio con relè per kit xenon



ART. 45751

- FILTRO
- VOLKSWAGEN, AUDI, SEAT, MERCEDES, SKODA 2011/2012



ART. 45700

- PORTALAMPADA XENON H7 PER BMW E39
- (2 MODELLO) 1 COPPIA



ART. 45707

- PORTALAMPADA XENON IN METALLO H7 PER
- BMW X5, AUDI, VW PASSAT, OPEL VECTRA C, OPEL ASTRA H, SAAB 93, FORD FIESTA, NISSAN QASHQAI, ALCUNE MERCEDES ECC...
- ALFA MITO (CON PICCOLA MODIFICA) 1 COPPIA



ART. 45701

- PORTALAMPADA XENON H7 PER BMW E39
- (1 MODELLO) 1 COPPIA

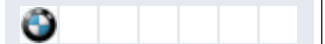

ART. 45716

- PORTALAMPADA XENON H7 PER MERCEDES BENZ, AUDI, BMW X5
- 1 COPPIA



ART. 45715

- PORTALAMPADA XENON H7 PER VW PASSAT, OPEL VECTRA C, SAAB 93, AUDI, BMW X5
- 1 COPPIA



ART. 45702

- PORTALAMPADA XENON H7 PER BMW E39 (3MODELLO 1996-2003)
- 1 COPPIA



ART. 45704

- PORTALAMPADA XENON H7 PER BMW E46 (MODELLO NERO) 1 COPPIA



ART. 45703

- PORTALAMPADA XENON H7 PER BMW E46 (MODELLO BIANCO)
- 1 COPPIA



ART. 45726

- PORTALAMPADA XENON D2S PER BMW E46 SERIE 3.
- CONVERTE DA H7 A D2S
- 1 COPPIA



ART. 45729

- ADATTATORE LAMPADA XENON H7
- CITROEN C5, PEUGEOT 508,3008, RENAULT CLIO SPORTOUR(2011)



ART. 45725

- PORTALAMPADA XENON H7 PER FIAT NUOVA 500
- 1 COPPIA

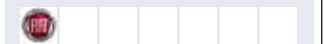

ART. 45718



- PORTALAMPADA XENON H7 PER FORD FOCUS "ANABBAGLIANTE"
- 1 COPPIA



ART. 45719



- PORTALAMPADA XENON H7/H1 PER FORD MONDEO "ABBAGLIANTE"
- 1 COPPIA



ART. 45722



- PORTALAMPADA XENON H7 PER FORD MAVERICK
- 1 COPPIA



ART. 45710



- PORTALAMPADA XENON H7/H1 PER FORD MONDEO "ANABBAGLIANTE"
- 1 COPPIA

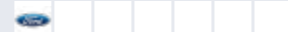

ART. 45733



- ADATTATORE/PORTALAMPADA H7
- LAND ROVER FREELANDER 2, FORD FOCUS E MONDEO CHIA-X



ART. 45706



- PORTALAMPADA XENON H1 FORD FOCUS "ABBAGLIANTE"
- 1 COPPIA



ART. 45731



- ADATTATORE/PORTALAMPADA H7
- HYUNDAI SANTA FE



ART. 45724



- PORTALAMPADA XENON H1 PER HONDA ODYSSEY CON 4 ALETTE VECCHIO MODELLO - 1 COPPIA



ART. 45717



- PORTALAMPADA XENON H7 PER HYUNDAI
- 1 COPPIA



ART. 45723



- PORTALAMPADA XENON H1 PER HONDA ODYSSEY CON 2 ALETTE NUOVO MODELLO - 1 COPPIA



ART. 45735



- PORTALAMPADA XENON H7 PER HYUNDAI
- 1 COPPIA



ART. 45705



- PORTALAMPADA XENON D2C PER MERCEDES 1 COPPIA



ART. 45736



- ADATTATORE/PORTALAMPADA H7 PER ANABBAGLIANTE
- KIA RIO, CARENS
- HYUNDAI ELANTRA



ART. 45712



- PORTALAMPADA XENON H1 PER MERCEDES BENZ 320
- 1 COPPIA



ART. 45734



- ADATTATORE/PORTALAMPADA H7
- VW GOLF VII, SCIROCCO 2012, TOURAN 2011
- SEAT ALAMBRA 2012
- MERCEDES SPRINTER 2014



ART. 45713



- PORTALAMPADA XENON H7 PER OPEL
- 1 COPPIA



ART. 45714



- PORTALAMPADA XENON H7 PER OPEL, HONDA CRV, MAZDA 3, ECC
- 1 COPPIA



ART. 45720



- PORTALAMPADA XENON H7 PER VW NEW BORA E BUICK NEW REAL
- 1 COPPIA



ART. 45708



- PORTALAMPADA XENON H7 PER VW GOLF V
- 1 COPPIA



ART. 45737



- ADATTATORE/PORTALAMPADA H7 PER ANABBAGLIANTE HYUNDAI TUCSON



ART. 45709



- PORTALAMPADA XENON H7 PER GOLF VI
- 1 COPPIA



ART. 45721



- PORTALAMPADA XENON H7 PER VW TOURAN, CADDY, JETTA...
- 1 COPPIA



H.O.D.®

High Definition Olive Lamp (H.O.D)

H.O.D.
È UN MARCHIO REGISTRATO
DA HAPPY SOUND SRL
PER L'ITALIA E RSM IN DATA 31/01/2014.
L'UTILIZZO DEL MARCHIO È CONSENTITO
SOLO ALLA NOSTRA CLIENTELA.

NUOVISSIMA TECNOLOGIA

50% DI LUCE EXTRA

GAS ALLO XENON INIETTATO ALL'INTERNO

OMOLOGATE LUNGA DURATA



**LUCE BIANCA FREDDA
UGUALE AI KIT ALLO XENON**

LE LAMPADINE ORIGINALI H.O.D. SONO IL FRUTTO DI UNA NUOVISSIMA TECNOLOGIA ALL'AVANGUARDIA, STUDIATA E BREVETTATA NEGLI STATI UNITI. LE H.O.D. NON SONO IN VETRO COME TUTTI GLI ALTRI TIPI DI LAMPADINE, MA SONO REALIZZATE AL QUARZO, ALL'INTERNO È CONTENUTO REALMENTE IL GAS XENON, LO STESSO GAS PRESENTE NELLE LAMPADINE DEI KIT ALLO XENON.



LA PARTICOLARE FORMA BOMBATA CHE RICORDA UN'OLIVA, PERMETTE LA COMBUSTIONE DEL GAS ALLO XENON CONTENUTO ALL'INTERNO DELLE LAMPADINE, A BASSO VOLTAGGIO,

QUINDI DIRETTAMENTE CON L'IMPIANTO ORIGINALE DEL VEICOLO A 12 VOLT E 24 VOLT, SENZA LA NECESSITÀ DI INSTALLARE LE CENTRALINE BALLAST AD ALTA TENSIONE.

CON LE H.O.D. SI OTTIENE UNA LUCE BIANCA FREDDA E BRILLANTE 5500K, UGUALE AI KIT ALLO XENON, PERTANTO È GARANTITA **UNA ILLUMINAZIONE SUPERIORE DEL 50% CON UNA ESTETICA MOLTO ELEGANTE.**

LE H.O.D. SONO INDISPENSABILI PER OTTENERE UNA ILLUMINAZIONE CHIARA E PROFONDA DELLA STRADA, RIDUCENDO IL RISCHIO DI INCIDENTI, SENZA DARE ALCUN FASTIDIO AGLI ALTRI VEICOLI.

LE NOSTRE H.O.D. HANNO UNA LUNGA DURATA E SONO LEGALI AVENDO TUTTE LE OMOLOGAZIONI RICHIESTE DALLA LEGGE, PERTANTO IN CASO DI POSTO DI BLOCCO DELLE FORZE DELL'ORDINE SI È IN PIENA REGOLA, ANCHE IN CASO DI REVISIONE DEL VEICOLO.

LE H.O.D. HANNO GLI STESSI WATT DI ASSORBIMENTO DELLE LAMPADINE ORIGINALI E SCALDANO IN EGUAL MISURA, PERTANTO È GARANTITO CHE NON RIPORTANO ALCUNA PROBLEMATICHE ALL'IMPIANTO DEL VEICOLO, ED IL COMPUTER DI BORDO NON SEGNALE ALCUN ERRORE.

LE H.O.D. POSSONO ESSERE INSTALLATE SUGLI ANABBAGLIANTI, ABBAGLIANTI E FENDINEBBIA DI QUALSIASI VEICOLO.

**DIFFIDATE DELLE NUMEROSE IMITAZIONI IN COMMERCIO NON OMOLOGATE!
LUMINOSITÀ 2500 LM - VISIBILITÀ OLTRE GLI 80 METRI**

BASE	CODICE	DESCRIZIONE	KELVIN	VOLT	WATT
HB1	HOD.HB1	COPPIA LAMPADINE H.O.D. LUCE BIANCA FREDDA come gli xenon	5500k	12 V	65/45 W
HB4/9006	HOD.HB4	COPPIA LAMPADINE H.O.D. LUCE BIANCA FREDDA come gli xenon	5500k	12 V	55 W
HB3/9005	HOD.HB3	COPPIA LAMPADINE H.O.D. LUCE BIANCA FREDDA come gli xenon	5500k	12 V	55 W
HB5	HOD.HB5	COPPIA LAMPADINE H.O.D. LUCE BIANCA FREDDA come gli xenon	5500k	12 V	65/55 W
H8	HOD.H8	COPPIA LAMPADINE H.O.D. LUCE BIANCA FREDDA come gli xenon	5500k	12 V	55 W
H9	HOD.H9	COPPIA LAMPADINE H.O.D. LUCE BIANCA FREDDA come gli xenon	5500k	12 V	65 W
H7	HOD.H7	COPPIA LAMPADINE H.O.D. LUCE BIANCA FREDDA come gli xenon	5500k	12 V	55 W
H4	HOD.H4	COPPIA LAMPADINE H.O.D. LUCE BIANCA FREDDA come gli xenon	5500k	12 V	55/60 W
H3	HOD.H3	COPPIA LAMPADINE H.O.D. LUCE BIANCA FREDDA come gli xenon	5500k	12 V	55 W
H11	HOD.H11	COPPIA LAMPADINE H.O.D. LUCE BIANCA FREDDA come gli xenon	5500k	12 V	55 W
H10	HOD.H10	COPPIA LAMPADINE H.O.D. LUCE BIANCA FREDDA come gli xenon	5500k	12 V	42 W
H1	HOD.H1	COPPIA LAMPADINE H.O.D. LUCE BIANCA FREDDA come gli xenon	5500k	12 V	55 W
H7	HOD.24VH7	COPPIA LAMPADINE H.O.D. LUCE BIANCA FREDDA come gli xenon	5500k	24 V	70 W
H4	HOD.24VH4	COPPIA LAMPADINE H.O.D. LUCE BIANCA FREDDA come gli xenon	5500k	24 V	75/70 W
H3	HOD.24VH3	COPPIA LAMPADINE H.O.D. LUCE BIANCA FREDDA come gli xenon	5500k	24 V	70 W
H1	HOD.24VH1	COPPIA LAMPADINE H.O.D. LUCE BIANCA FREDDA come gli xenon	5500k	24 V	70 W

EFFETTO GAS XENON - LUCE BIANCA FREDDA



LINEA AUTO 12 VOLT

- LP.H10WHITE COPPIA LAMPADINE H10 SUPER WHITE 55 WATT 12 VOLT
- LP.H11WHITE COPPIA LAMPADINE H11 WHITE 55 WATT 12 VOLT
- LP.H13WHITE COPPIA LAMPADINE H13 SUPER WHITE 55 WATT 12 VOLT
- LP.H15WHITE COPPIA LAMPADINE H15 SUPER WHITE 55/15 WATT 12 VOLT
- LP.H16WHITE COPPIA LAMPADINE H16 SUPER WHITE 35 WATT 12 VOLT
- LP.H1WHITE COPPIA LAMPADINE H1 WHITE 55 WATT 12 VOLT
- LP.H3WHITE COPPIA LAMPADINE H3 WHITE 55 WATT 12 VOLT
- LP.H4WHITE COPPIA LAMPADINE H4 WHITE 90/100 WATT 12 VOLT
- LP.H7WHITE COPPIA LAMPADINE H7 WHITE 55 WATT 12 VOLT
- LP.H8WHITE COPPIA LAMPADINE H8 SUPERWHITE 55 WATT 12 VOLT
- LP.H9WHITE COPPIA LAMPADINE H9 WHITE 55 WATT 12 VOLT
- LP.HB1WHITE COPPIA LAMPADINE HB1 12 VOLT SUPER WHITE 55 WATT 12 VOLT
- LP.HB3WHITE COPPIA LAMPADINE HB3 WHITE 55 WATT 12 VOLT
- LP.HB4WHITE COPPIA LAMPADINE HB4 WHITE 55 WATT 12 VOLT
- LP.HB5WHITE COPPIA LAMPADINE HB5 SUPER WHITE 55 WATT 12 VOLT
- LP.T10WHITE COPPIA LAMPADINE ALOGENE T10 SUPER WHITE 5 WATT 12 VOLT
- LP.T20WHITE COPPIA LAMPADINE ALOGENE T20 SUPER WHITE 21/5 WATT 12 VOLT
- LP.HIR2WHITE COPPIA LAMPADINE HIR2 SUPER WHITE 55 WATT 12 VOLT

LINEA TRUCK 24 VOLT

- LP.24VH1WHITE COPPIA LAMPADINE 24 VOLT H1 70W SUPER WHITE
- LP.24VH3WHITE COPPIA LAMPADINE 24 VOLT H3 70W SUPER WHITE
- LP.24VH4WHITE COPPIA LAMPADINE 24 VOLT H4 75/70W SUPER WHITE
- LP.24VH7WHITE COPPIA LAMPADINE 24 VOLT H7 70W SUPER WHITE
- LP.24VT10WHITE COPPIA LAMPADINE ALOGENE T10 SUPER WHITE 5 WATT 24 VOLT



LINEA 12 VOLT

- LP.T4W 10PZ LAMPADA 12 VOLT T4W BA9S
- LP.T5W 10 PZ LAMPADA T5 W1,2W 12W 1,2W
- LP.T20Y21W 10 PZ LAMPADA T20 WY21W 12V 21W ARANCIONE
- LP.T2021W 10 PZ LAMPADA T20 W21W 12V 21W
- LP.T20215W 10 PZ LAMPADA T20 W21/5W 12V 21/5W
- LP.T15W 10 PZ LAMPADA T15 W18W 12V
- LP.T11/41 10 PZ LAMPADA ALOGENA T11 SILURO 41MM 5WATT
- LP.T11/39 10 PZ LAMPADA ALOGENA T11 SILURO 39MM 5WATT
- LP.T11/36 10 PZ LAMPADA ALOGENA T11 SILURO 36MM 5WATT
- LP.T10/5W 10PZ LAMPADA 12 VOLT W5W TUTTO VETRO
- LP.R2640 LAMPADA ASSIMMETRICA R2 G40 45/40W P45T
- LP.HS1 LAMPADA ALOGENA HS1 12 VOLT 35/35W PX43T (MOTO)
- LP.H7 LAMPADA H7 12V 55WATT
- LP.H6 LAMPADA ALOGENA H6 12VOLT 35/35W BA20D (SCOOTER)
- LP.H5 LAMPADA H5 12V 60/55WATT
- LP.H4 LAMPADA ALOGENA H4 60/55W
- LP.H3 LAMPADA H3
- LP.H1 LAMPADA 12 VOLT H1 55W
- LP.BAY15D 10 PZ LAMPADA ALOGENA 12 VOLT S25 P21/5W
- LP.BAU15S 10 PZ LAMPADA S25 PY21W BAU15S 12V 21W -ARANCIO
- LP.BA9S 10 PZ LAMPADA H6W BA9S 12V 6W (PIEDI STORTI SFALSATI)
- LP.BA15S5W 10PZ LAMPADA ALOGENA G 18,5 12V5W R5W
- LP.BA15S10W 10 PZ LAMPADA ALOGENA G 18,5 12V 10W R10W
- LP.BA15S 10 PZ LAMPADA ALOGENA 12 VOLT S25 P21W
- LP.B35 LAMPADA ALOGENA B35 12 VOLT 35/35 W BA20D (SCOOTER)

LINEA 24 VOLT

- LP.24VT105 CONFEZIONE 10PZ LAMPADA ALOGENA 24V T10W W5W
- LP.24VT5W CONFEZIONE 10PZ LAMPADA ALOGENA T5 W1,2W 24V 1,2W
- LP.24VT4W CONFEZIONE 10PZ LAMPADA ALOGENA T4W BA9S T8,5 24V 4W
- LP.24VT11/41 CONFEZIONE 10PZ LAMPADA ALOGENA SILURO T11 24V 10W 41mm
- LP.24VH7 LAMPADA ALOGENA 24 VOLT H7 70W
- LP.24VH4 LAMPADA ALOGENA 24 VOLT H4 75/70W
- LP.24VH3 LAMPADA ALOGENA 24 VOLT H3 70W
- LP.24VH1 LAMPADA ALOGENA 24 VOLT H1 70W
- LP.24VBA15D CONFEZIONE 10PZ LAMPADA ALOGENA S25 24V 21/5W
- LP.24VBA15SA CONFEZIONE 10PZ LAMPADA ALOGENA S25 BA15S 24V 21W ARANCIONE
- LP.24VBA15S5W CONFEZIONE 10PZ LAMPADA ALOGENA G18,5 24V 5W
- LP.24VBA15S10W CONFEZIONE 10PZ LAMPADA ALOGENA G18,5 24V 10W
- LP.24VBA15S CONFEZIONE 10PZ LAMPADA ALOGENA S25 24V 21W



A large rectangular area with a thin black border, containing 25 horizontal white lines for writing notes.

A large rectangular area with a thin black border, containing 25 horizontal white lines for writing notes.

COMMERCIAL & MARKETING DIRECTOR - Fabio Gentile
fabiogentile@happysoundgroup.com - +39 345 3222107

IMPORT/EXPORT DIRECTOR - Fabio Gentile
fabiogentile@happysoundgroup.com - +39 345 3222107

DIRETTORE AMMINISTRATIVO - Giovanni Terenzi - info@happysound.it

DIRETTORE TECNICO - Giovanni Terenzi - info@happysound.it

TRASMISSIONE ORDINI - ordini.hsgroup@gmail.com

SEGRETERIA - Francesca Maria Ivagnes - happysoundsanmarino@gmail.com

ASSISTENZA TECNICA - service.hsgroup@gmail.com

VUOI RICEVERE ASSISTENZA TECNICA?
PER ESSERE INSERITO NEL NOSTRO
GRUPPO DI WHATSAPP NAZIONALE,
DEDICATO ESCLUSIVAMENTE
ALL'ASSISTENZA TECNICA SUL LED AUTOMOTIVE
SCRIVI AL NUMERO +39 345 3222107

PER ATTIVARE LA GARANZIA
DEI NOSTRI PRODOTTI È NECESSARIO
REGISTRARLI ENTRO 30 GIORNI DALL'ACQUISTO,
UTILIZZANDO QUESTO QR CODE.



HS GROUP
AUTOMOTIVE LED LIGHT LEADER

www.happysoundgroup.com

 **HAPPY SOUND GROUP (H S GROUP)**

 **hs_group_official**

 **hsgroup.ledspecialist**

HAPPY SOUND SRL

Strada del Bargello, 80 - 47891 Falciano (RSM) - Tel. 0549 970563 - Fax 0549 972275

info@happysoundgroup.com

